

BEFORE YOU GET STARTED...

We're confident you'll love your gorgeous new Next furniture. However, it's worth making absolutely certain before you put it all together.

So, let's quickly run through these three steps:

1. COLOUR

Make sure you're happy with the colour
No need to unpack everything, just check the first component.

2. PROTECTIVE PACKAGING

If you're happy, then it's time to get opening! Start by laying everything out on the protective packaging – this will prevent anything getting scratched.

3. PARTS PAGE

Finally, double check you have all the pieces by referencing the parts page of the instructions.

TIPS FOR RETURNS

Not completely happy with the product? No problem. We just need everything back in the original packaging, so follow the steps below and this will ensure a super-smooth returns process and no delay to your refund.

DO



- Check everything is there (the 'parts page' is a handy checklist).
- Pop all the loose fittings and fixtures into the packaging provided or tie them up in a plastic bag.
- Wrap all the big components back up in the original protective packaging.
- Close up the box and seal it securely (don't be afraid to use plenty of tape).

DON'T



- Leave anything assembled - all components should be dismantled and separately packed.
- Put loose fixtures and fittings straight into the box.
- Throw it back in the box carelessly – as it may get damaged.

next
HOME

Then just give us a call on 0333 777 8999 and we'll sort out a pick up time for you.

next

SHELDON BARSTOOL

Assembly instructions

Actual product size
H96/111 x W45 x D49cm

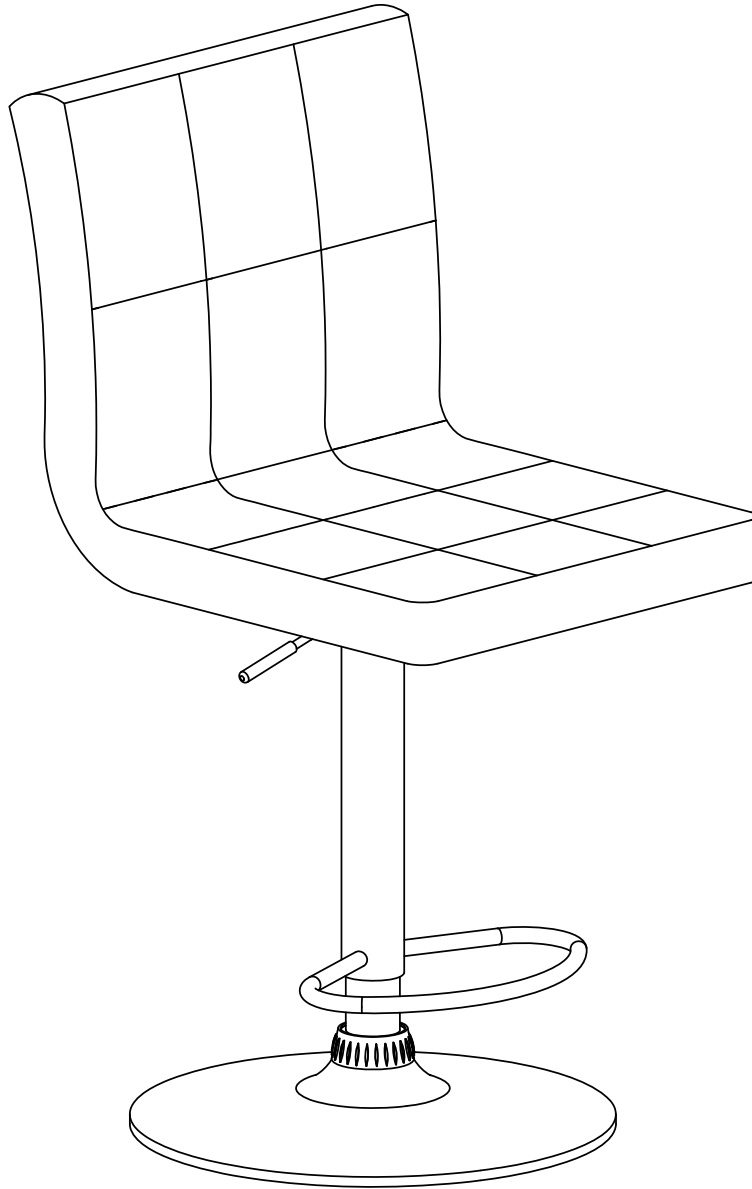

Need Help?

With: Assembly instructions
Missing or damaged parts

CALL: 0333 777 8999

IMPORTANT – RETAIN FOR FUTURE REFERENCE

BEFORE YOU START

Number of people required to assemble

One people is required to assemble this item.

Tools required

Time to assemble



15 minutes

Missing parts

If you are missing any fixtures and fittings for your product, please contact our customer service team on **0333 777 8999**, and they will be happy to arrange for a replacement to be sent to you free of charge.

Home service technicians

If you have a fault with your product please contact our customer service team on **0333 777 8999**. If you have had the product for 28 days or less you may be offered a replacement, refund or for a fully trained home service technician to visit your home to assess the fault and repair the product where possible. If you have had the product for more than 28 days we will send an independant home service technician to review and repair the product where possible and recommend further action.

You can write to us at

Home Customer Services
Next Retail Ltd,
Desford Road,
Leicester,
LE19 4AT

Item No.	Description	Composition
583683	Faux Leather Dark Natural	Face 100% Polyurethane, Base 65% Polyester, 35% Cotton
515178	Faux Leather Dark Grey	Face 100% Polyurethane, Base 65% Polyester, 35% Cotton
598140	Faux Leather Black	Face 100% Polyurethane, Base 65% Polyester, 35% Cotton

To View our full furniture range please visit www.next.co.uk

GETTING TO KNOW YOUR PRODUCT

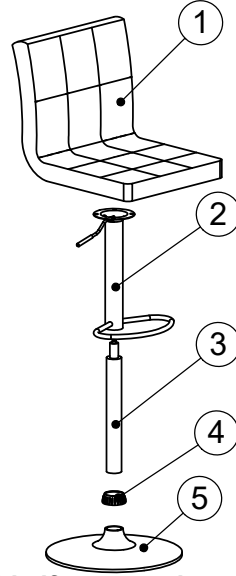

Components supplied. Please use this guide if you require replacement parts.

Ref	Dimensions	Visual	Qty	Ctn
1	49x38cm		1	1
2	30x39cm		1	1
3	60cm		1	1

Ref	Dimensions	Visual	Qty	Ctn
4	7.5cm		1	1
5	45cm		1	1

Fixtures and fittings supplied (actual size)

Ref	Dimensions	Qty	*Extra Fittings
D	M6 x 16mm	4	1

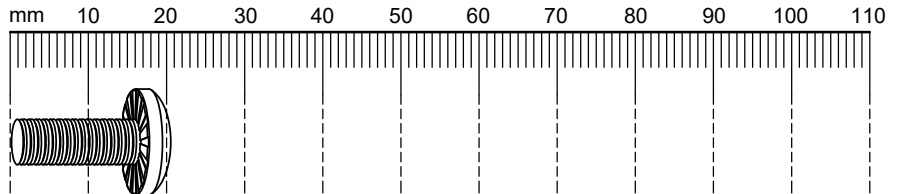

Fixtures and fittings supplied(not to scale)

Ref	Dimensions	Visual	Qty
C	5mm		1

Ref	Dimensions	Visual	Qty	*Extra Fittings
H	18mm		4	1

1

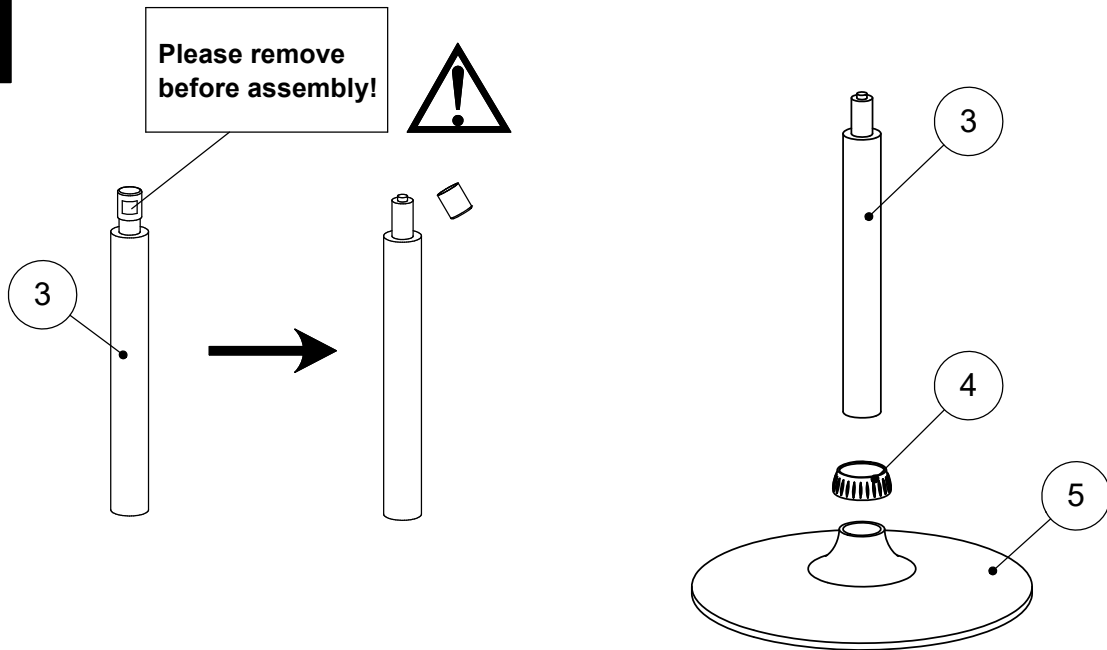

2

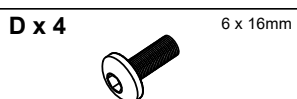
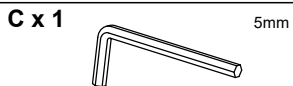
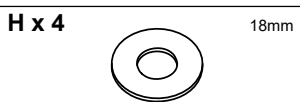
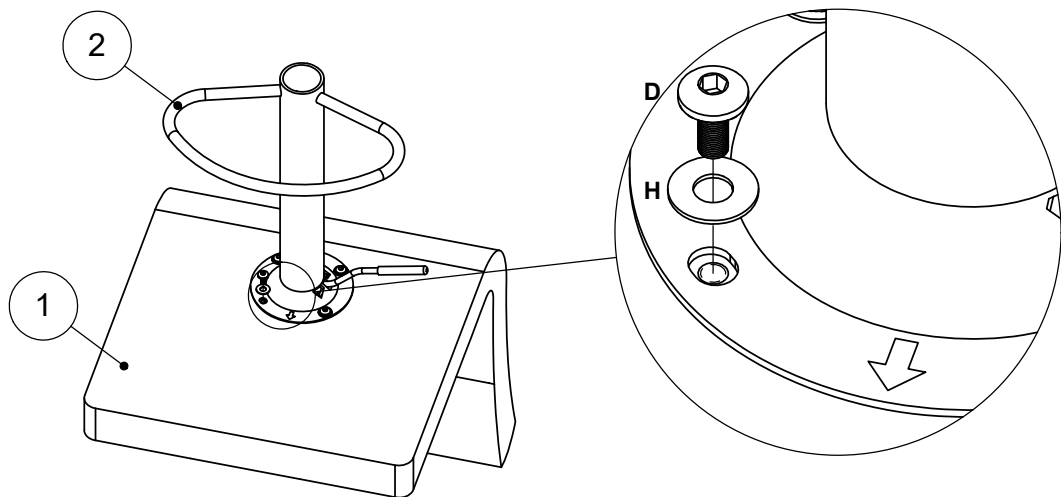

3

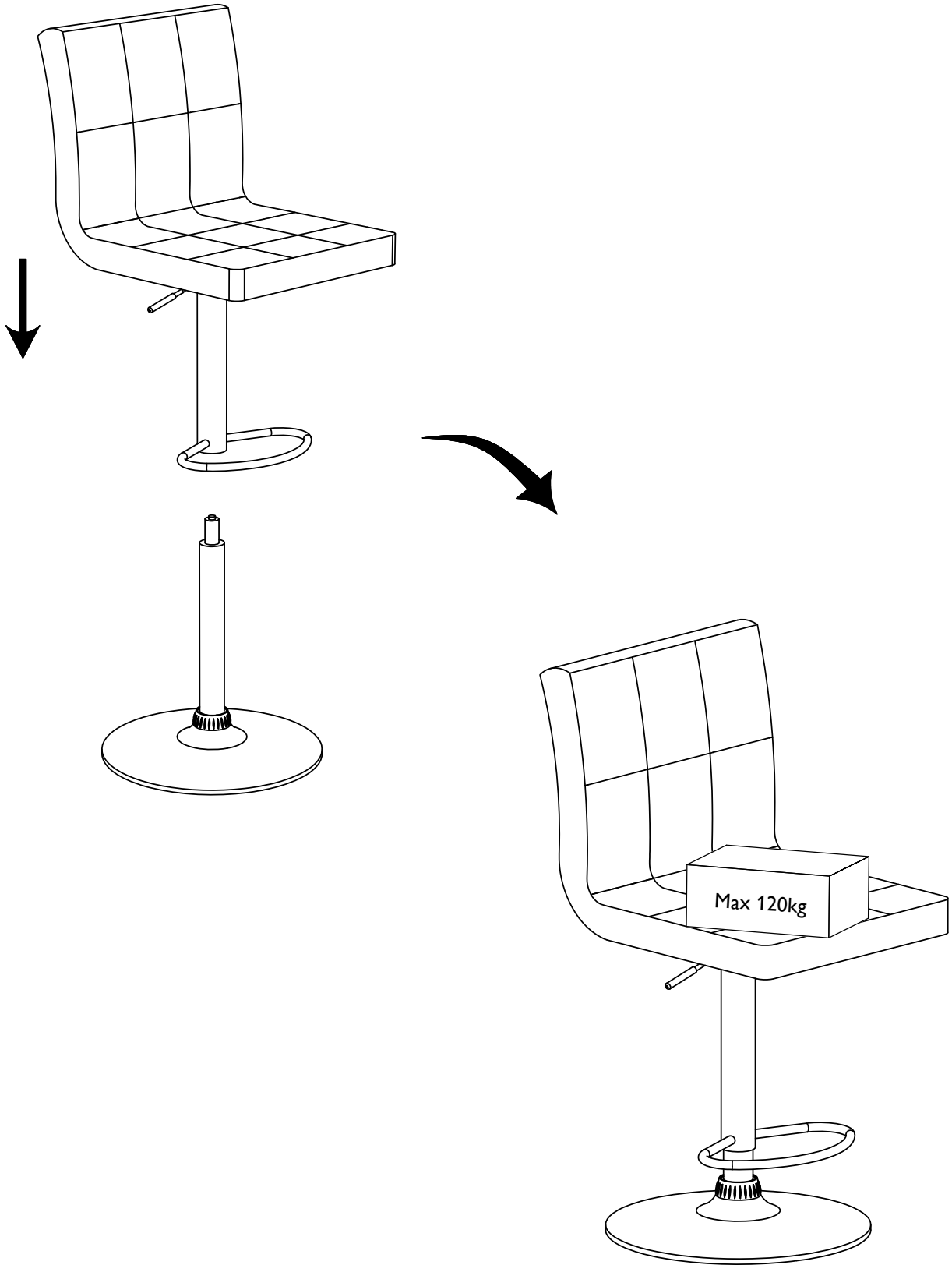

Warnings

We suggest you retain these instructions for future reference.

Keep fittings out of children's reach and keep children well away from the construction area.

This product should only be used on firm, level ground.

Please periodically check all fittings and re-tighten as necessary.

Avoid exposing the furniture to excessive heat or direct sunlight as this can cause deterioration of the colour.

Unwrap all packaging materials and place the components on top of the carton box or on a clean floor to protect it from damage.

Do's

We suggest you spend a short time reading through this leaflet before you start.

When you are ready to start, make sure that you have the right tools and plenty of space.

Unwrap all packaging materials and place the components on a clean surface to protect it from damage.

We recommend that the packaging is used to protect the surfaces during assembly.

Carefully check that you have all the parts before beginning assembly

Ensure the product is fully assembled as illustrated and all fixings are fully tightened before use.

Wipe occasionally with a soft cloth slightly dampened with water. Then buff with a dry clean soft cloth.

Don'ts

Do not drag or pull your furniture.

Do not use silicone based furniture polish. Silicone in furniture polishes can break down the finish.

Never allow any kind of liquid to remain on your furniture.

Absorption can cause wood to warp or finishes to de-laminate.

Do not stand or lean back on your chairs.

SHELDON BARSTOOL

Assembly instructions

