

BEFORE YOU GET STARTED...

We're confident you'll love your gorgeous new Next furniture. However, it's worth making absolutely certain before you put it all together.

So, let's quickly run through these three steps:

1. COLOUR

Make sure you're happy with the colour
No need to unpack everything, just check the first component.

2. PROTECTIVE PACKAGING

If you're happy, then it's time to get opening! Start by laying everything out on the protective packaging – this will prevent anything getting scratched.

3. PARTS PAGE

Finally, double check you have all the pieces by referencing the parts page of the instructions.

TIPS FOR RETURNS

Not completely happy with the product? No problem. We just need everything back in the original packaging, so follow the steps below and this will ensure a super-smooth returns process and no delay to your refund.

DO



- Check everything is there (the 'parts page' is a handy checklist).
- Pop all the loose fittings and fixtures into the packaging provided or tie them up in a plastic bag.
- Wrap all the big components back up in the original protective packaging.
- Close up the box and seal it securely (don't be afraid to use plenty of tape).

DON'T



- Leave anything assembled - all components should be dismantled and separately packed.
- Put loose fixtures and fittings straight into the box.
- Throw it back in the box carelessly – as it may get damaged.

next
HOME

Then just give us a call on 0333 777 8999 and we'll sort out a pick up time for you.

next

Claro round dining

566291

Assembly instructions

Actual product size:

Dia. 100 x H75cm

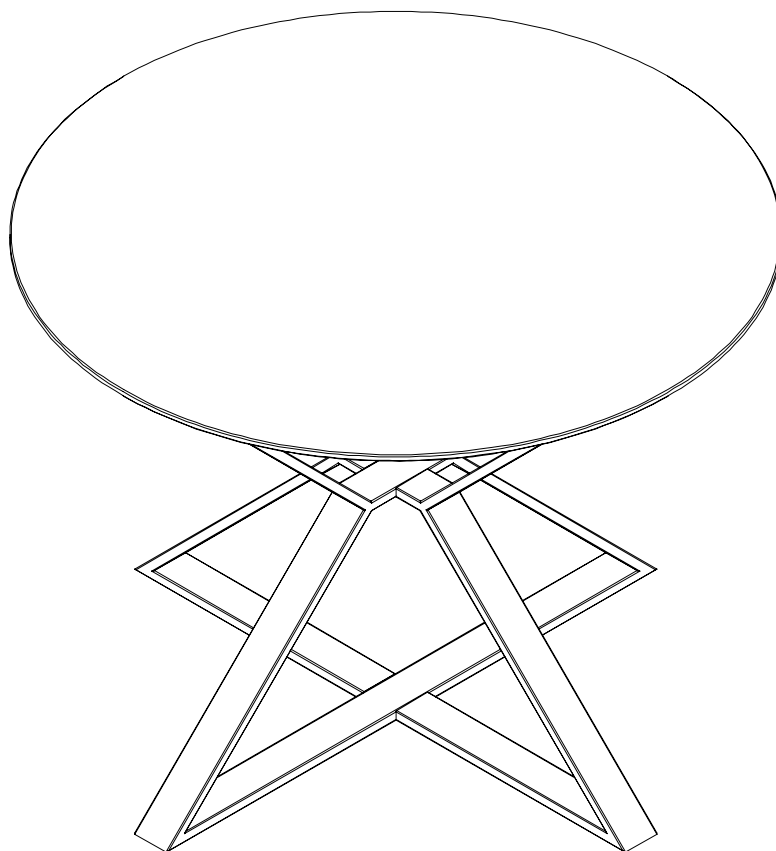

Need Help?

With: Assembly instructions
Missing or damaged parts

CALL: 0333 777 8999

IMPORTANT – RETAIN FOR FUTURE REFERENCE

BEFORE YOU START

Warnings

We suggest you retain these instructions for future reference

Keep fittings out of children's reach and keep children well away from construction area

This product should only be used on firm level ground

Avoid exposing the furniture to excessive heat or direct sunlight as this can cause deterioration of the UV bosses glue. Unwrap all packaging materials and place the components on top of the carton box or on a clean floor to protect it from damage.

Do's

We suggest you spend a short time reading through this leaflet before you start

Glass can scratch in normal use therefore protect surfaces from scratches and marks by using mats and coasters.

When you are ready to start, make sure that you have the right tools and plenty of space

We recommend that the packaging is used to protect the surfaces during assembly

Carefully check that you have all the parts before beginning assembly

Ensure the product is fully assembled as illustrated and all fixings fully tightened before use. Check fixings regularly to ensure they remain tight

Please take care when handling or moving the furniture as careless handling may cause damage or injury

It is recommended that before moving heavy objects to a new location they are completely dis-assembled to avoid personal injury or damage to the furniture. Please be careful to retain all fittings when doing this.

Always wipe dry after cleaning

To clean your item, please use a soft cloth slightly dampened with water and wipe clean. Then buff with a dry clean cloth.

Don'ts

Do not stand or sit down on your table

Do not use the glass as a chopping surface. Do not strike the glass with hard or pointed items

If the glass is chipped or broken stop using the product and consult the manufacturer or supplier.

Number of people required to assemble

Two people are required to assemble this item.

Time to assemble

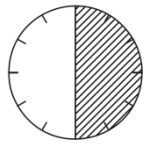

30 mins



Tools required

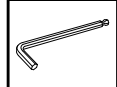

Missing parts

If you are missing any fixtures and fittings for your product please contact our customer service team on 0333 777 8999 and they will be happy to arrange for a replacement to be sent to you free of charge.

Home service technicians

If you have a fault with your product please contact our customer service team on 0333 777 8999. If you have had the product for 28 days or less you may be offered a replacement, refund or for a fully trained home service technician to visit your home to assess the fault and repair the product where possible. If you have had the product for more than 28 days we will send an independent home service technician to review and repair the product where possible and recommend further action.

You can write to us at

Home Customer Services
Next Retail Ltd,
Desford Road,
Leicester,
LE19 4AT

**To view our full furniture range please visit
www.next.co.uk**

GETTING TO KNOW YOUR PRODUCT

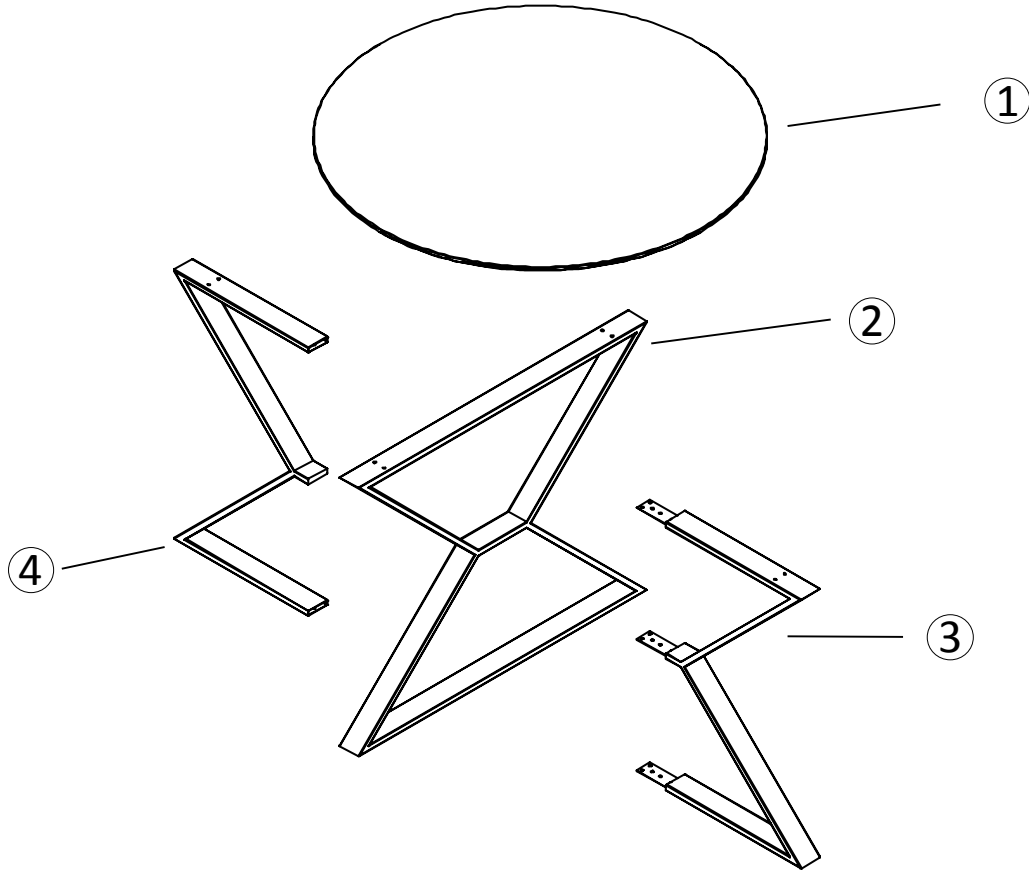

Ref	Dimensions	Visual	Qty	Ctn
1	Dia.100 x 2cm		1	2
2	90 x 72.4 x 6cm		1	1
3	52 x 72.4 x 6cm		1	1
4	42 x 72.4 x 6cm		1	1

Fixtures and fittings supplied (actual size)

Ref	Dimensions	Qty	*Extra
A	M6 X 16mm	15	2
B	M8 X 20mm	8	1

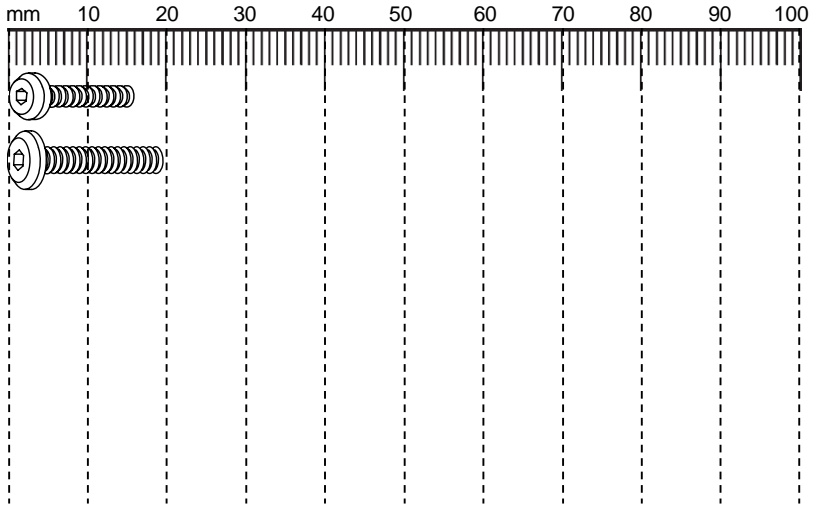

Fixtures and fittings supplied (not to scale)

Ref	Dimensions	Visual	Qty
C	5mm		1

3

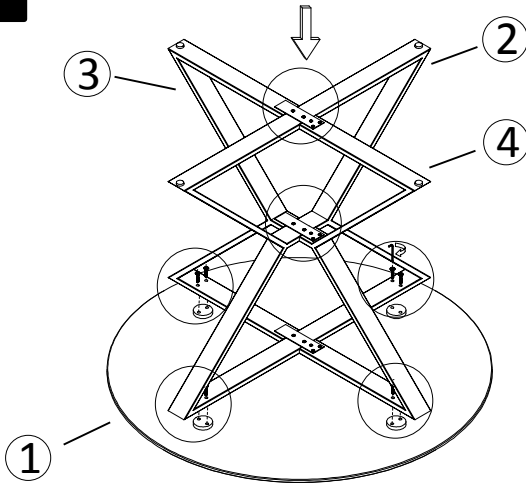

With 2 people carefully align the legs as shown. Finger tighten the bolts (B) ensuring no gaps between legs 2, 3 and 4. Using the allen key C, first fully tighten bolts A and then proceed to fully tighten bolts B.

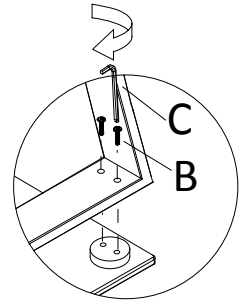
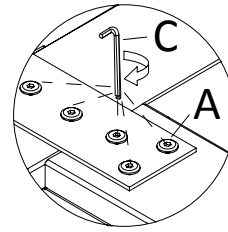

B x 8

M8 x 20mm

4

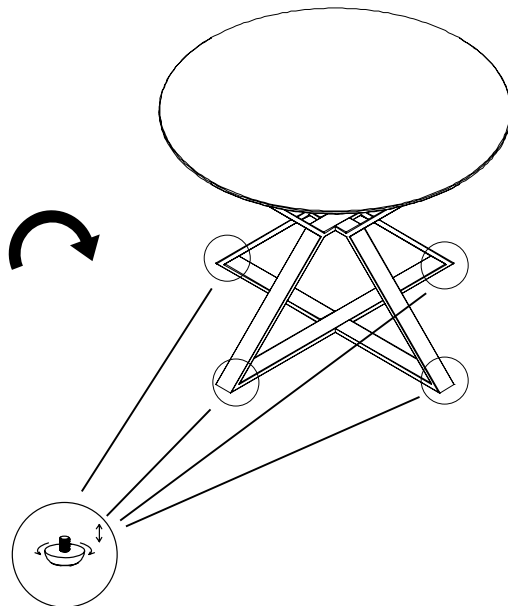
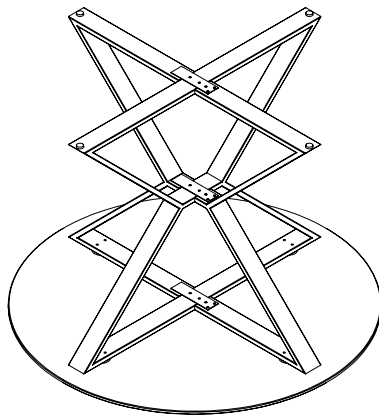

If table is not level, adjust it with the adjustable feet.

next

Claro round dining

566291

Assembly instructions

Actual product size:

Dia. 100 x H75cm

