

NEXT

BOBBIN RED FLOOR LAMP
620815
Assembly instructions

Actual product size

H161 x D45 cm

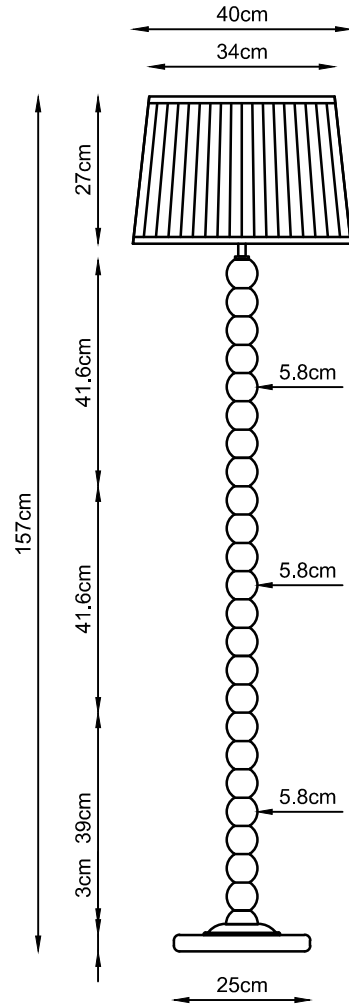

NEXT

BOBBIN RED FLOOR LAMP
620815
Assembly instructions

Actual product size

H157 x D40 cm

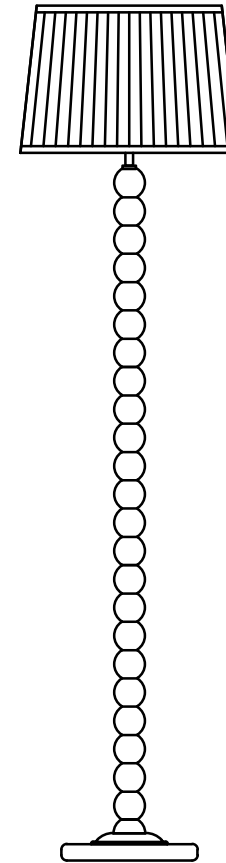

Need Help?

with: Assembly instructions
Missing or damaged parts

CALL: 0333 777 8999

IMPORTANT-RETAIN FOR FUTURE REFERENCE

BEFORE YOU START

Warnings

We suggest you retain these instructions for future reference. For your safety, this product must be installed in accordance with Local Building Regulations. If in any doubt, or required by the law, consult a competent person who is registered with an electrician self-certification scheme. Further information is available online or from your Local Authority

This light is suitable for indoor use only

We suggest you retain these instructions for future reference.

Recommended Bulb: ES 6W LED MAX 10W

Do's

We suggest you spend a short time reading through this leaflet before you start

When you are ready to start, make sure that you have the right tools and plenty of space

Unwrap all packaging materials and place the components on top of the carton box or on a clean floor to protect it from damage

We recommend that the packaging is used to protect the surfaces during assembly. Carefully check that you have all the parts before beginning assembly

Ensure the product is fully assembled as illustrated and all fixings fully tightened before use. Check fixings regularly to ensure they remain tight

Always switch off the supply before changing light bulbs or cleaning

Allow bulbs to cool down before handling

Don'ts

We recommend cleaning with a soft dry cloth, do not use abrasive materials as these will rub away the protective coating.

Time to assemble

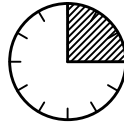

15mins

Missing parts

If you are missing any fixtures and fittings for your product please contact our customer service team on 0333 777 8999 and they will be happy to help.

Cleaning Care

We recommend cleaning with a soft dry cloth. Do not use abrasive materials as these will rub away the protective coating.

Maintenance

To ensure your safety, if the cable becomes damaged it must be replaced by only a qualified person.

Safety information

For your safety, please remember the following:

- Always switch off the power supply before changing lightbulbs or cleaning
- Allow bulbs to cool down before handling.

You can write to us at

Home Customer Services
Next Retail Ltd.
Desford Road, Leicester, LE19 4AT

Next Retail (Ireland) Ltd.
13-18 City Quay, Dublin 2, D02 ED70

To view our full range please visit
www.next.co.uk

GETTING TO KNOW YOUR PRODUCT

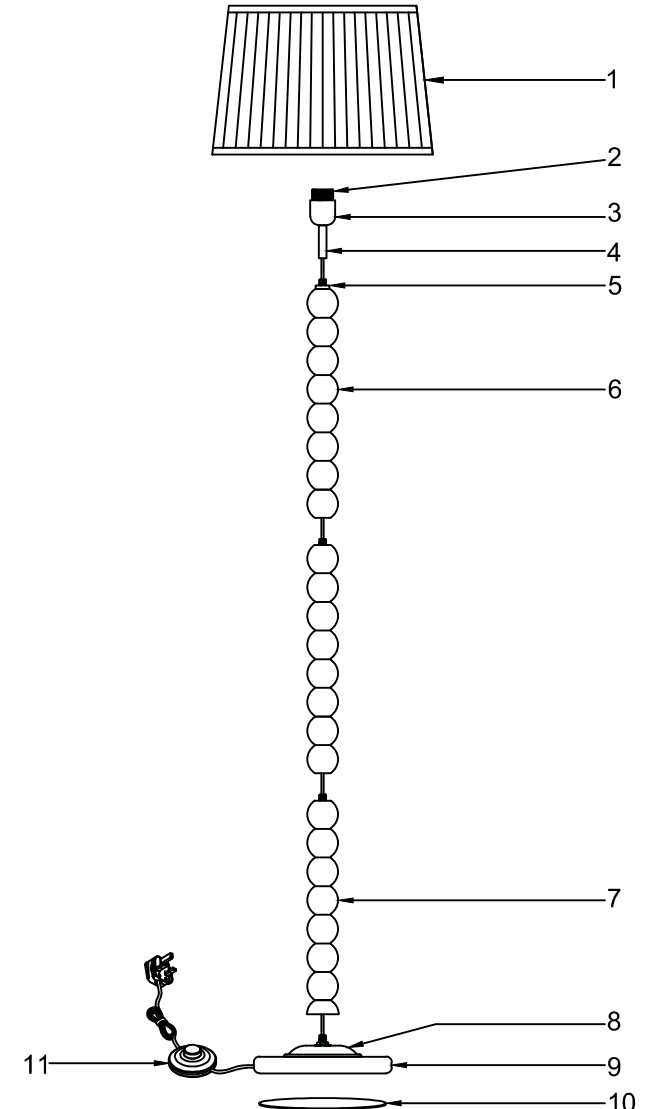

GETTING TO KNOW YOUR PRODUCT

Ref	Description	Specification	Qty	Remark
1	Fabric Shade	D40*H27cm	1	
2	Lampholder	E27	1	
3	Lampholder Cup	D4.5*H4.5 cm	1	
4	Metal Stem	D1.4*H6 cm	1	
5	Screw	D2.5*H0.6 cm	1	
6	Wooden Stem	D5.8*L41.6cm	2	
7	Wooden Stem	D5.8*H39 cm	1	
8	Wooden block	D14*H2 cm	1	
9	Wooden base	D25*H3 cm	1	
10	EVA pad	D23*T0.2 cm	1	
11	Cable	L350 cm	1	

1

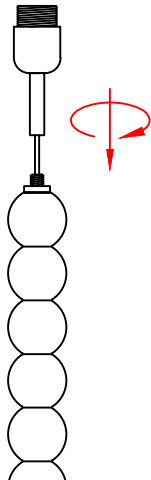

Step 1

Gently pull the cable through at the base and screw part 4 into part 5.

2

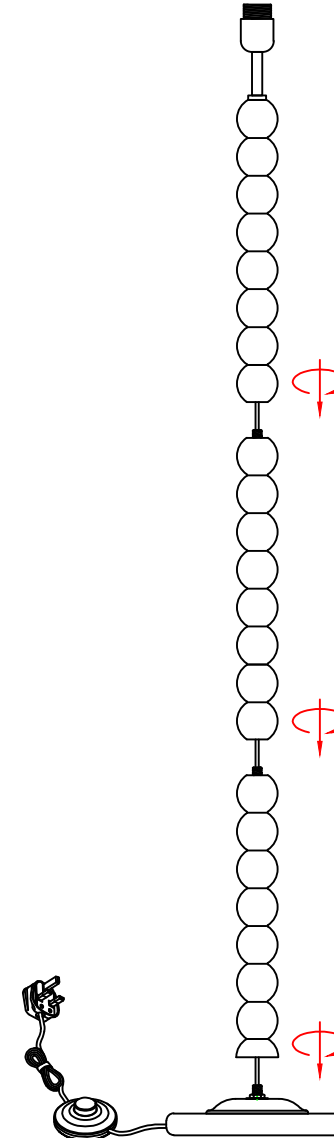

Step 2

Continue to gently pull cable through at the base and screw part 6 and 7 into place, and finally screw part 7 to base.

NEXT

BOBBIN RED FLOOR LAMP 620815 Assembly instructions

3

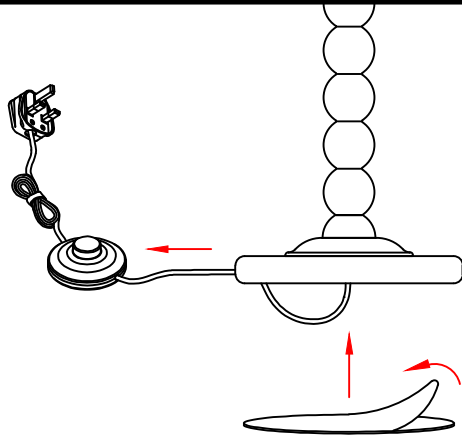

Step 3

Ensure cable is flush in base and attach felt cover to base.

4

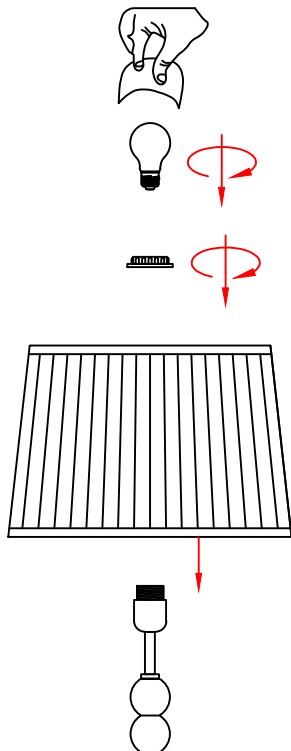

Bulb: Max 10W E27

Step 4

Remove the shade ring from the lamp holder, then fit the shade onto lamp holder and secure into position with the shade ring. Screw bulb into lampholder. (Bulb not included)

NEXT

BOBBIN RED FLOOR LAMP

Instructions for repackaging

Thank you for purchasing this Next lighting product. We hope you will be delighted with your purchase, but in the event that you wish to return the product, please follow the repackaging instructions below.

1

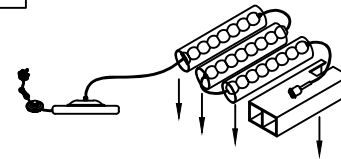

2

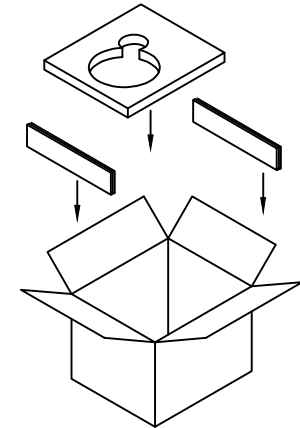

3

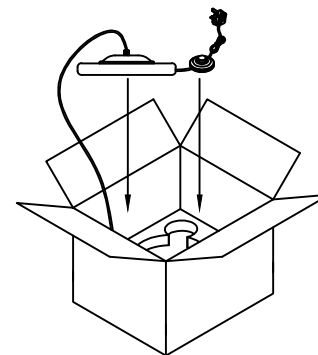

4

