

# BEFORE YOU GET STARTED...

*We're confident you'll love your gorgeous new Next furniture. However, it's worth making absolutely certain before you put it all together.*

*So, let's quickly run through these three steps:*

## 1. COLOUR

Make sure you're happy with the colour  
No need to unpack everything, just check the first component.

## 2. PROTECTIVE PACKAGING

If you're happy, then it's time to get opening! Start by laying everything out on the protective packaging – this will prevent anything getting scratched.

## 3. PARTS PAGE

Finally, double check you have all the pieces by referencing the parts page of the instructions.

## TIPS FOR RETURNS

Not completely happy with the product? No problem. We just need everything back in the original packaging, so follow the steps below and this will ensure a super-smooth returns process and no delay to your refund.

DO



- Check everything is there (the 'parts page' is a handy checklist).
- Pop all the loose fittings and fixtures into the packaging provided or tie them up in a plastic bag.
- Wrap all the big components back up in the original protective packaging.
- Close up the box and seal it securely (don't be afraid to use plenty of tape).

DON'T



- Leave anything assembled - all components should be dismantled and separately packed.
- Put loose fixtures and fittings straight into the box.
- Throw it back in the box carelessly – as it may get damaged.

next  
HOME

Then just give us a call on 0333 777 8999 and we'll sort out a pick up time for you.

**Actual product size**

H45 x W44 x D44cm

H40 x W39 x D39cm

H35 x W33 x D33cm

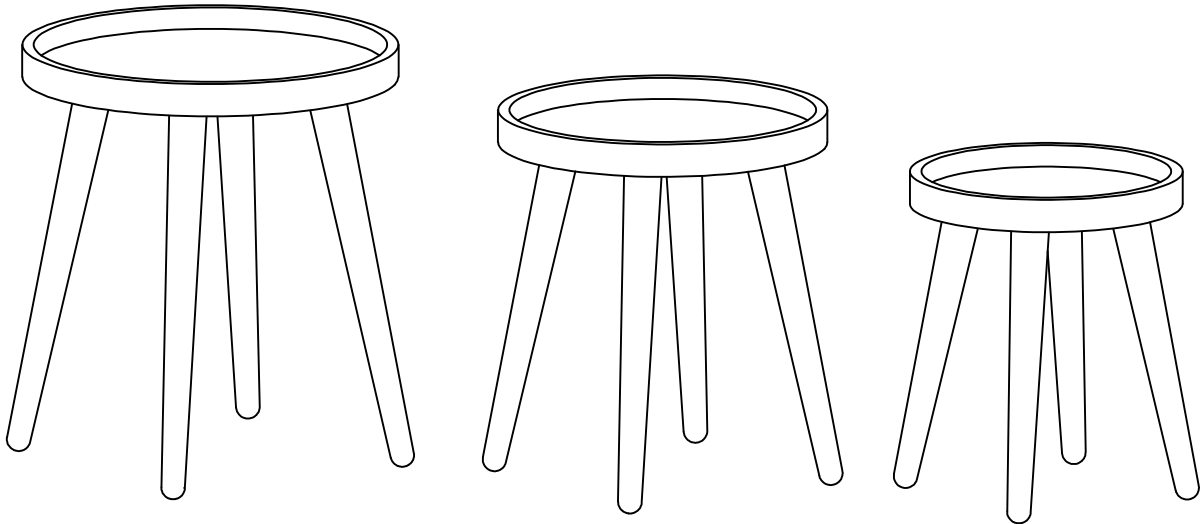

**Need Help?**

With: Assembly instructions  
Missing or damaged parts

**CALL: 0333 777 8999**

**IMPORTANT – RETAIN FOR FUTURE REFERENCE**

## BEFORE YOU START

### Warnings

We suggest you retain these instructions for future reference.

Keep fittings out of children's reach and keep children well away from the construction area.

This product should only be used on firm, level ground.

Avoid exposing the furniture to excessive heat or direct sunlight as this can cause deterioration of the colour.

Unwrap all packaging materials and place the components on top of the carton box or on a clean floor to protect it from damage.

### Do's

We suggest you spend a short time reading through this leaflet before you start.

When you are ready to start, make sure that you have the right tools and plenty of space.

Unwrap all packaging materials and place the components on a clean surface to protect it from damage.

We recommend that the packaging is used to protect the surfaces during assembly.

Carefully check that you have all the parts before beginning assembly.

Due to the size of the product we recommend that it is assembled in the room intended for use.

Ensure the product is fully assembled as illustrated and all fixings are fully tightened before use.

Wipe occasionally with a soft cloth slightly dampened with water. Then buff with a dry clean soft cloth.

Wood will mellow and change colour over time, we recommend that ornaments and items placed on the surface are moved regularly for the first few months to prevent uneven mellowing.

### Don'ts

Do not drag or pull your furniture.

Do not use silicone based furniture polish. Silicone in furniture polishes can break down the finish.

Never allow any kind of liquid to remain on your furniture. Absorption can cause wood to warp or finishes to de-laminate.

Do not place hot items (e.g. hot drinks) directly on to the wood surface. Please make sure you use a placement or coaster.

### Number of people required to assemble

One persons are required to assemble this item.

### Time to assemble

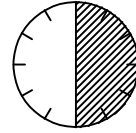

Under 30Minutes

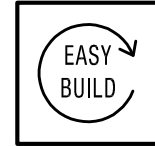

### Missing parts

If you are missing any fixtures and fittings for your product please contact our customer service team on 0333 777 8999 and they will be happy to arrange for a replacement to be sent to you free of charge.

### Home service technicians

If you have a fault with your product please contact our customer service team on 0333 777 8999. If you have had the product for 28 days or less you may be offered a replacement, refund or for a fully trained home service technician to visit your home to assess the fault and repair the product where possible. If you have had the product for more than 28 days we will send an independant home service technician to review and repair the product where possible and recommend further action.

### You can write to us at



Home Customer Services  
Next Retail Ltd,  
Desford Road,  
Leicester,  
LE19 4AT

To View our full furniture range please visit  
[www.next.co.uk](http://www.next.co.uk)

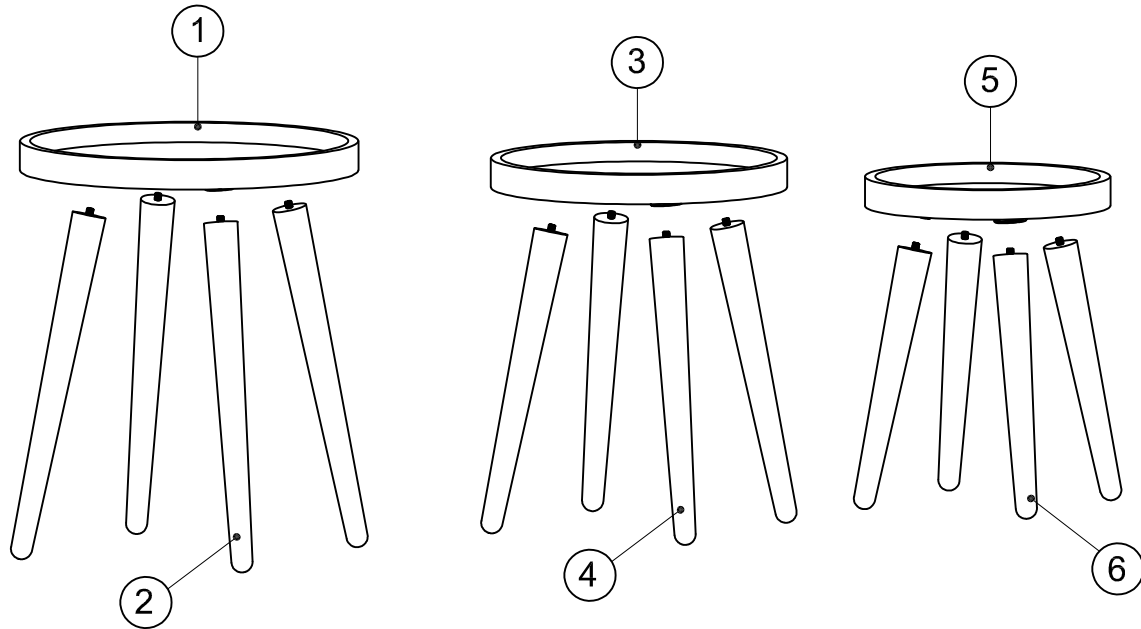
## GETTING TO KNOW YOUR PRODUCT

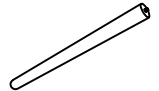

Components supplied. Please use this guide if you require replacement parts.

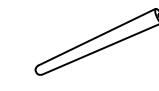
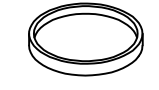
Ref	Dimensions	Visual	Qty	Ctn
1	DIA 40 x 3.5cm		1	
2	DIA 4 x 41.5cm		4	
3	DIA 35 x 3.5cm		1	
4	DIA 4 x 36.4cm		4	
5	DIA 29 x 3.5cm		1	

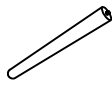
Ref	Dimensions	Visual	Qty	Ctn
6	DIA 4 x 31.3cm		4	

1

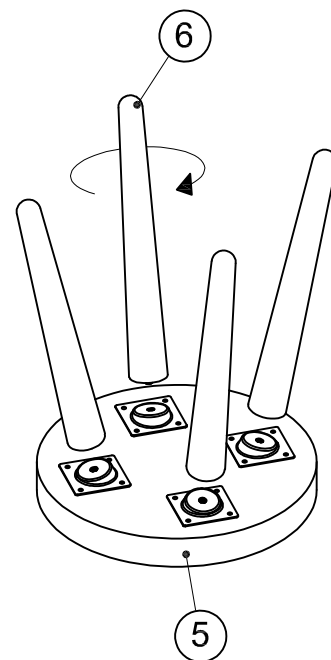
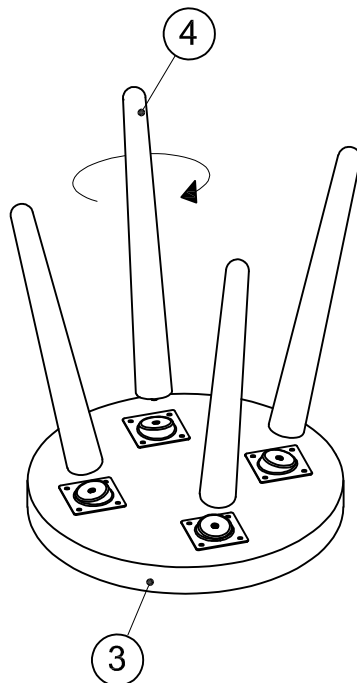
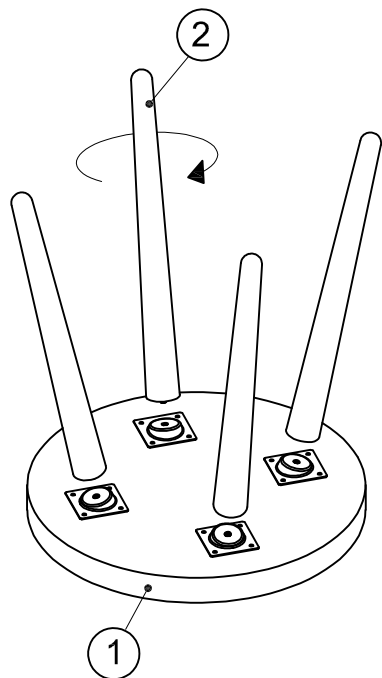

**Actual product size**

H45 x W44 x D44cm

H40 x W39 x D39cm

H35 x W33 x D33cm

