

# Birlea®

## Assembly Instructions

---

Thank you for  
purchasing a  
Birlea product

For a chance to win a Love2Shop voucher simply post a picture of your new product on your preferred social channels tagging Birlea Furniture. One winner will be selected at random each month.

\*Terms & conditions may apply.

---

### Are you happy with your purchase?

**Yes:** That's great, we would love to hear more from you. Please leave us a review on our Trustpilot link on the QR code here. Your feedback will be greatly appreciated.



**No:** If for any reason there is something missing, indifferent or incorrect with your order, please contact the retailer that you purchased your item from.

Please note that this items build time is around 45 minutes.



[www.birlea.com](http://www.birlea.com)



## ASSEMBLY INSTRUCTIONS HIGHGATE 3 DOOR WARDROBE

**IMPORTANT: READ THESE INSTRUCTIONS CAREFULLY BEFORE ASSEMBLING OR USING YOUR HIGHGATE 3 DOOR WARDROBE .**

**PLEASE KEEP THESE INSTRUCTIONS FOR FUTURE REFERENCE.**

### **HEALTH & SAFETY:**

**DO NOT** use this item if any parts are missing, damaged or worn.

**DO NOT** use this item unless all fixings are secured.

Please keep small parts out of reach of children.

Always use on a level, even surface.

It is recommended that two people handle and assemble the item.

Birlea advise you use the wall straps provided to further enhance the safety of this product.

### **CARE & MAINTENANCE:**

Assemble in the room of use.

To avoid damages assemble the item on a soft, clean surface

Periodically check all screws & fixings to ensure they are secure.

**DO NOT** push the item as this will damage the base.

Always lift the item with two people to reposition.

Keep any sharp objects away from the item.

This product is manufactured in pine which is a wood with natural characteristics including knots, grains, clusters or indentations.

On unpacking the item you may notice an odour due to production processes but this will disappear after a period of time.

**DO NOT** place the item next to a radiator or direct sunlight - this item is susceptible to temperature change. It is recommended an even room temperature be maintained with no sudden fluctuations.

**DO NOT** place hot or cold items directly onto the surface of the item as marking will occur

For general cleaning use a duster or damp cloth (almost dry) not wet - do not use soap and water, detergents, aerosol sprays or any polish as use of these materials would invalidate any claims.

**DO NOT** place the item onto wet or damp flooring as staining may occur to the floor.

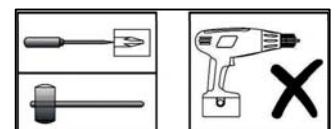
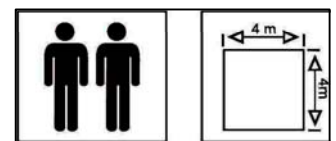
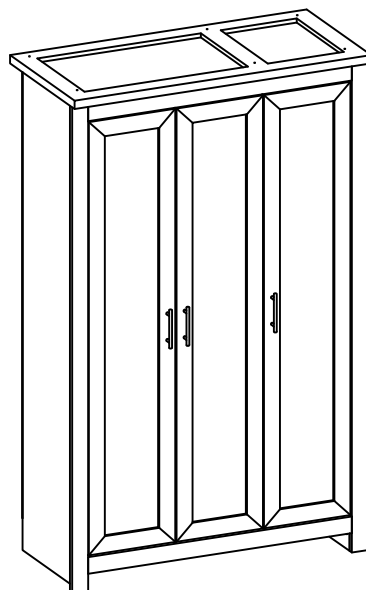

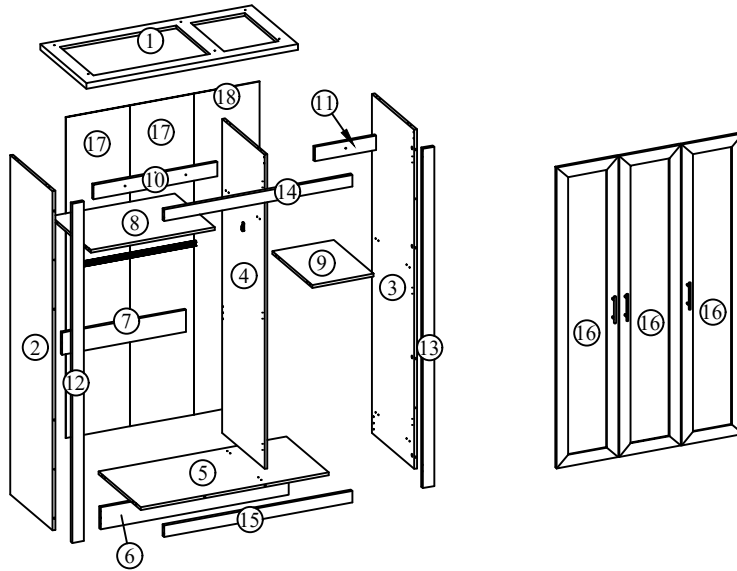

**PARTS LIST**

Carton 1 of 3:

Part	Description	Qty
4	Center Panel	1
14	Top Post Panel	1
15	Bottom Post Panel	1
16	Door	3

**PARTS LIST**

Carton 2 of 3:





















Part	Description	Qty
2	Left Panel	1
3	Right Panel	1
12	Left Post Panel	1
13	Right Post Panel	1
17	Back Panel	2
18	Back Panel	1

**PARTS LIST**

Carton 3 of 3:

Part	Description	Qty
1	Top Panel	1
5	Bottom Panel	1
6	Plinth Panel	1
7	Back Support Panel	1
8	Fix Shelf Panel	1
9	Fix Shelf Panel (Small)	1
10	Top Support Panel	1
11	Top Support Panel (Small)	1

**HARDWARE LIST: Carton 1 of 3**

Part	Description	Qty
A	CAM NUT 15mm 	31
B	CAM BOLT 	31
C	WOOD DOWEL M6 x 25mm 	44
D	COUNTERSUNK SCREW M3.5 x 12mm 	4
E	COUNTERSUNK SCREW M4 x 16mm 	38
F	COUNTERSUNK SCREW M4 x 25mm 	3
G	COUNTERSUNK SCREW M4 x 65mm 	8
H	SCREW M4 x 22mm 	6
I	HINGES 7/8" 	6
J	METAL BAR HANDLE 96mm 	3
K	PVC NAIL 	4
L	NAIL 	40
M	OVAL BRACKET 	2
N	OVAL PIPE (648mm) 	1
O	COUNTERSUNK SCREW M4 x 45mm 	2
S	HINGES 2/8" 	3
T	DOOR STOPPER 	2
<b>WALL FIXING KIT</b>		
P	WASHER (M4) 	4
Q	ANTI TIP STRAP 	2
R	COUNTERSUNK SCREW M4 x 20mm 	4

\*\* You will need a screwdriver and a small mallet ( NOT provided)

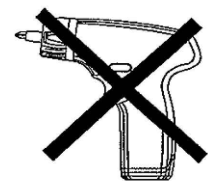



Measure Tape



**\*\* WARNING: THE USE OF POWER TOOLS TO ASSEMBLE THIS PRODUCT WILL INVALIDATE ANY CLAIM AND MAY DAMAGE THIS PRODUCT MAKING IT UNSAFE.**

1

A		4
B		14
C		4

Insert hardware part A & part B using a screwdriver (not provided).  
Insert hardware part C using a small mallet (not provided).  
DO NOT use any power tools as this may damage the frame and will invalidate any claim.



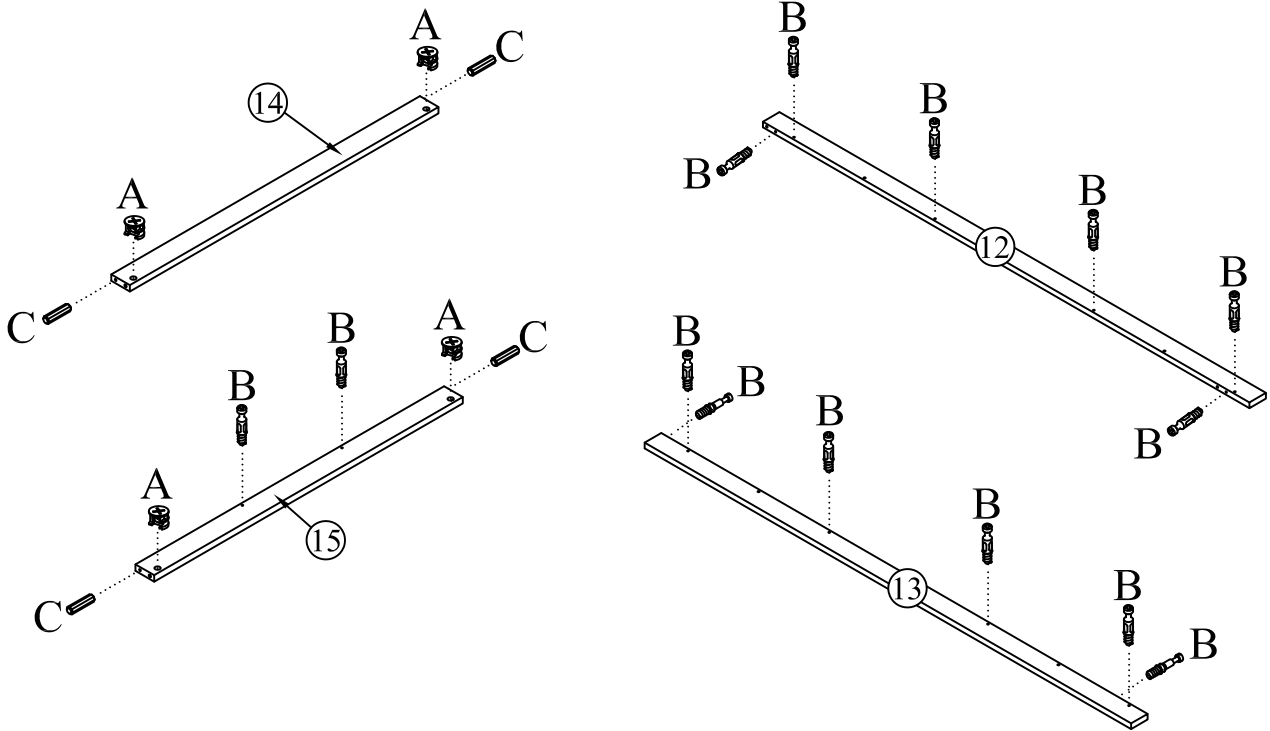

Vendor: S000398

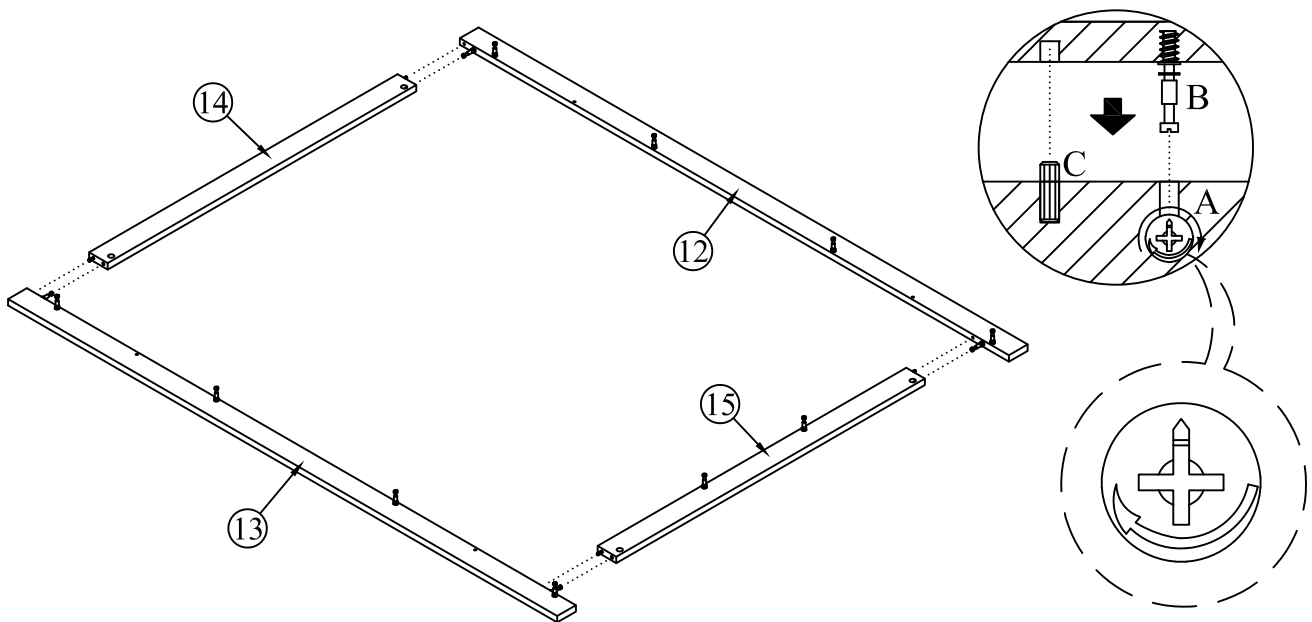

2

Attach the Post Panel together (12), (13), (14) & (15) by screwdriver (not provided).  
**DO NOT** use any power tools as this may damage the frame and will invalidate any claim.



3	A		12
	B		3
	C		16
	D		2
	M		1



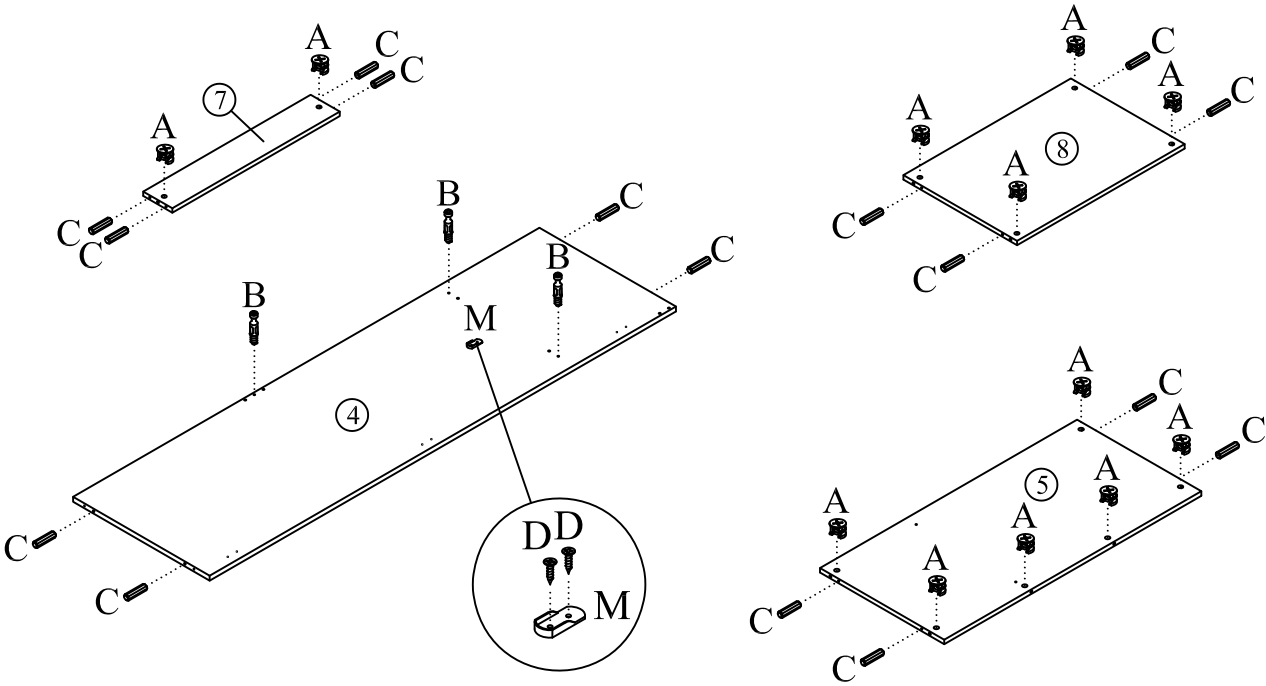



Insert hardware part A & part B using a screwdriver (not provided).  
 Insert hardware part C using a small mallet (not provided).  
 Fix hardware M with screw D using screwdriver (not provided).  
**DO NOT** use any power tools as this may damage the frame and will invalidate any claim.

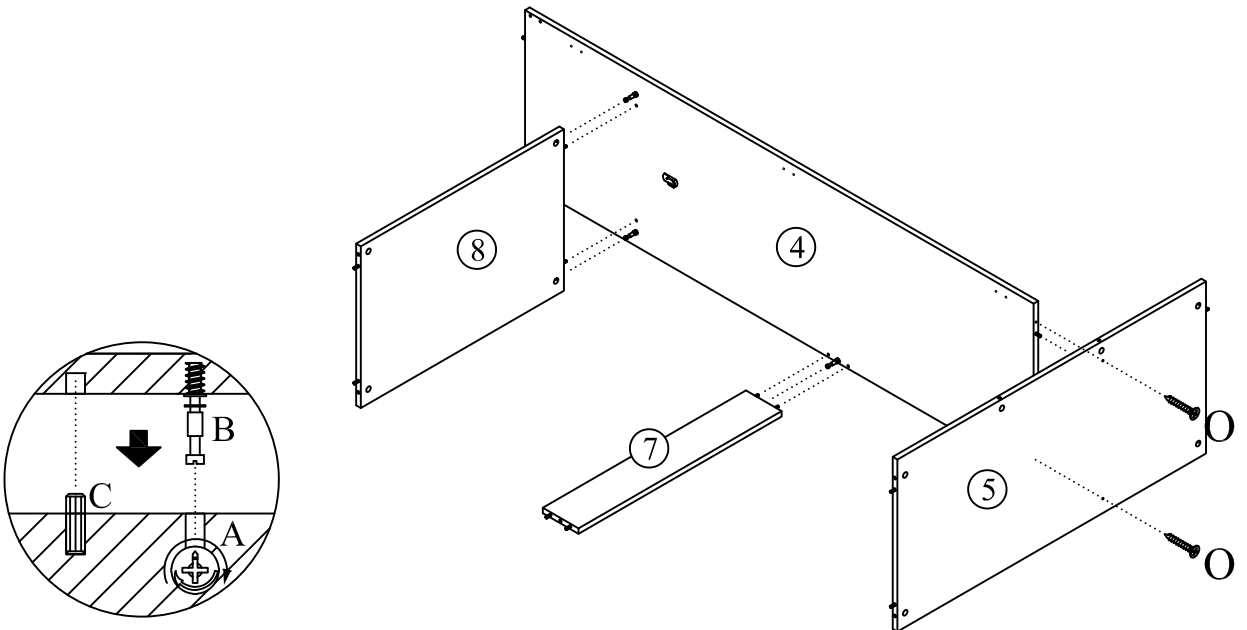

4	O		2
---	---	---	---

Attach Bottom Panel (5) to Center Panel (4) with screw O by screwdriver (not provided).  
 Attach Fix Shelf Panel (8) and Back Support Panel (7) to Center Panel (4) by screwdriver (not provided).  
**DO NOT** use any power tools as this may damage the frame and will invalidate any claim.



5	A		9
	B		6
	C		12
	D		2
	K		2
	M		1

Insert hardware part A & part B using a screwdriver (not provided).  
 Insert hardware part C using a small mallet (not provided).  
 Insert hardware part K using a small mallet (not provided).  
 Fix hardware M with screw D using screwdriver (not provided).  
**DO NOT** use any power tools as this may damage the frame and will invalidate any claim.

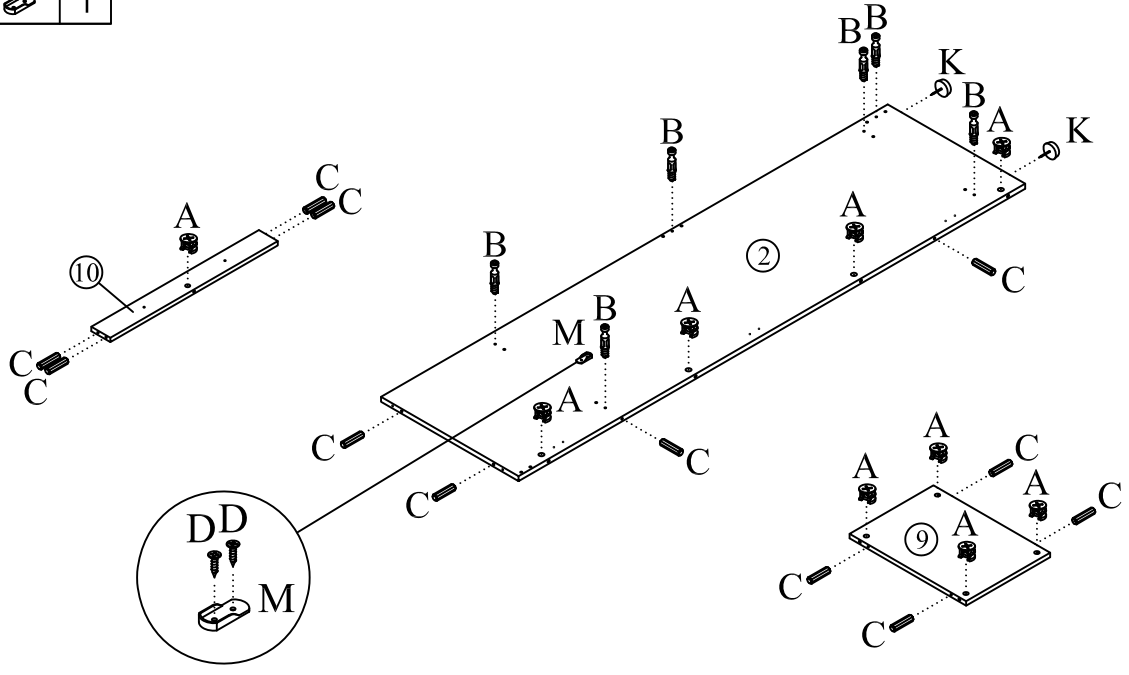



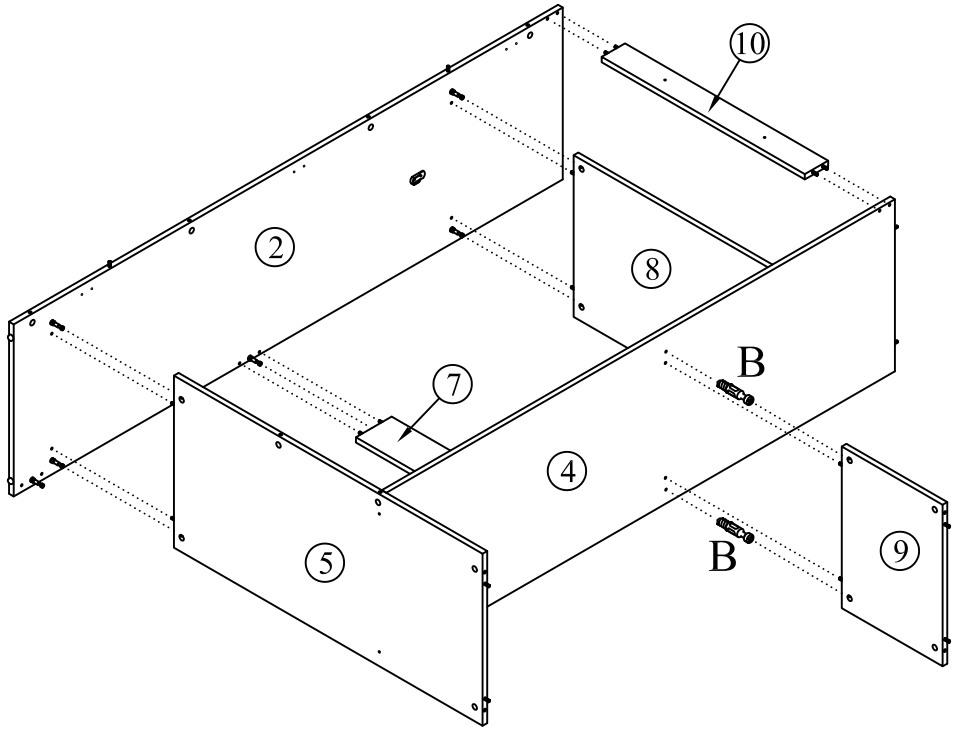
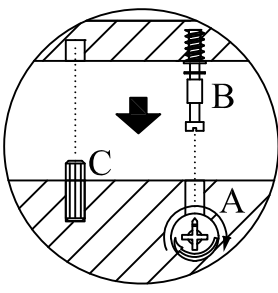

6	B		2
---	---	---	---

Before attach Fix Shelf Panel (small) (9) to Center Panel (4) insert hardware part B by screwdriver (not provided).  
 Attach Left Panel (2) to Bottom Panel (5), Fix Shelf Panel (8), Back Support Panel (7) and Top Support Panel (10) by screwdriver (not provided).  
**DO NOT** use any power tools as this may damage the frame and will invalidate any claim.



7

A		6
B		5
C		12
K		2

Insert hardware part A & part B using a screwdriver (not provided).

Vendor: S000398

Insert hardware part C using a small mallet (not provided).

Insert hardware part K using a small mallet (not provided).

DO NOT use any power tools as this may damage the frame and will invalidate any claim.

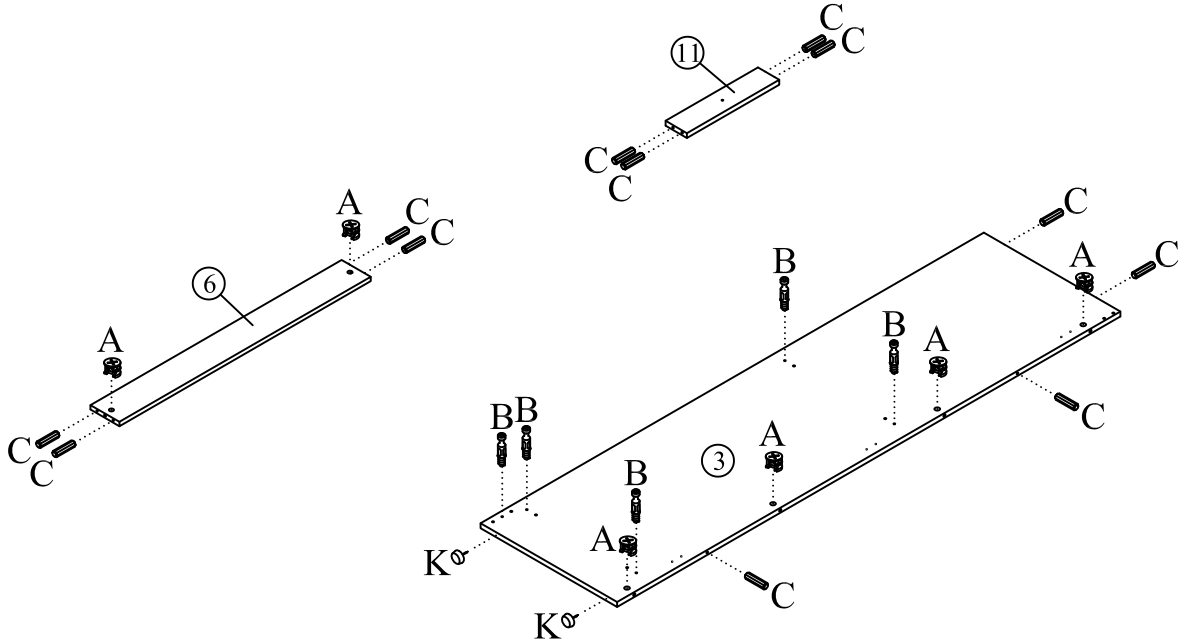

8

Attach Right Panel (3) to Bottom Panel (5), Fix Shelf Panel (small) (9), Plinth Panel (6) and Top Support Panel (small) (11) by screwdriver (not provided).

DO NOT use any power tools as this may damage the frame and will invalidate any claim.

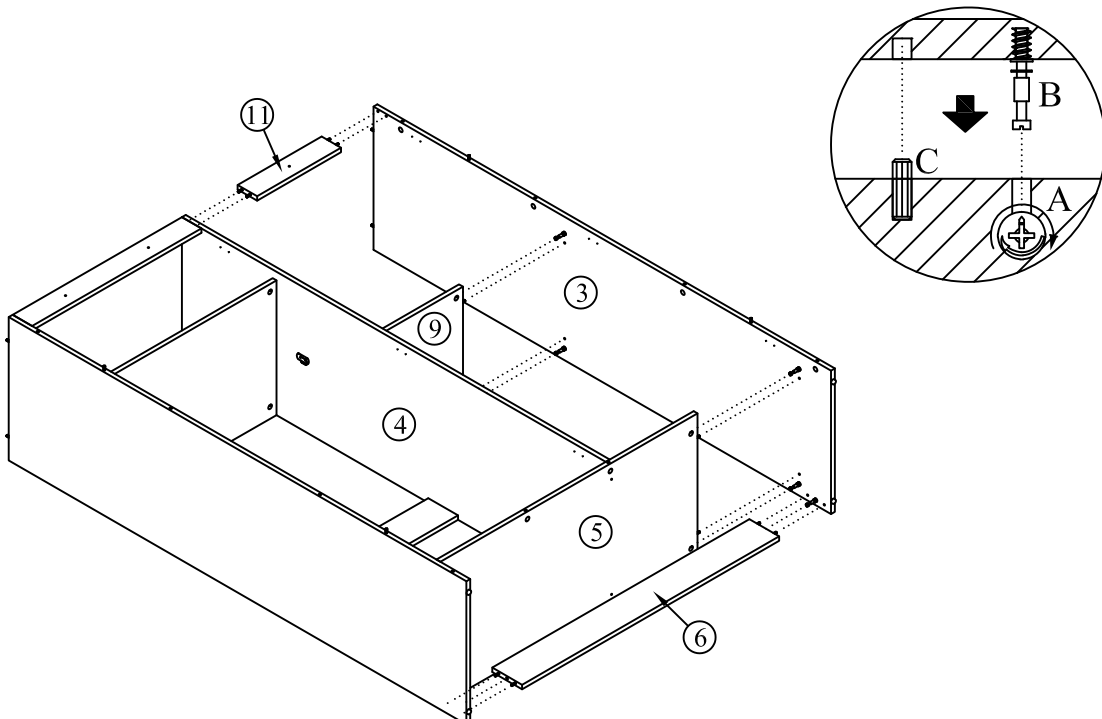

9 

F		3
---	---	---

Attach ALL Post Panel (12), (13), (14) & (15) to Left, Right & Bottom Panel (2), (3) & (5) by screwdriver (not provided).  
Fix both Top Support Panel (8) to Top Post Panel (14) using screw F by screwdriver (not provided).  
**DO NOT** use any power tools as this may damage the frame and will invalidate any claim.

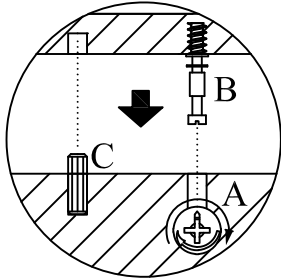
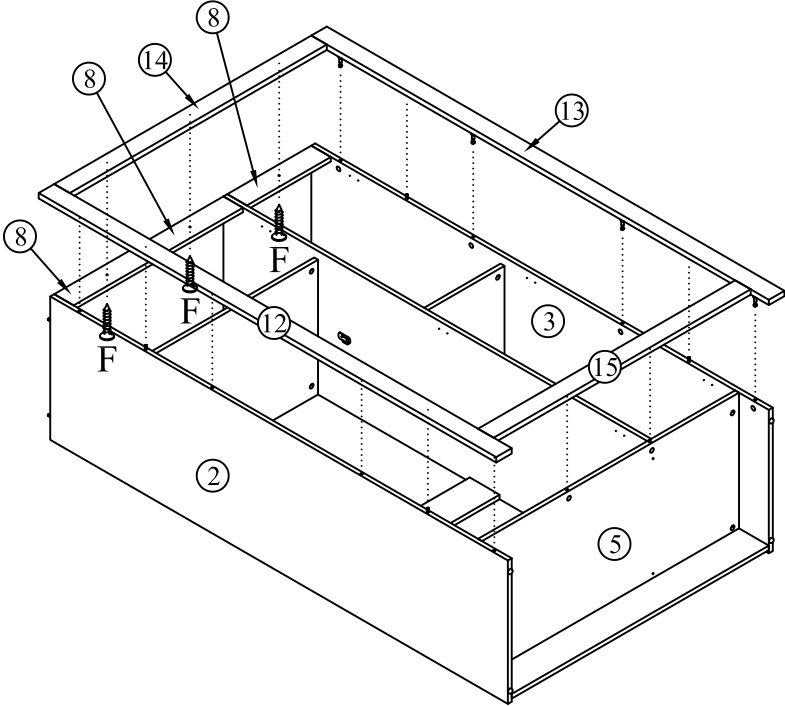

10 

B		1
---	---	---

Insert hardware part B using a screwdriver (not provided).  
**DO NOT** use any power tools as this may damage the frame and will invalidate any claim.

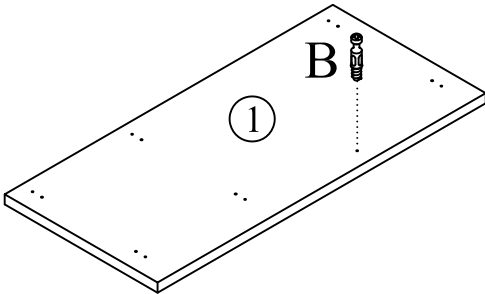

11

G		8
---	---	---

Attach the Top Panel (1) to Left , Right Panel (2) , (3) , Center Panel (4), and Left and Right Post Panel (12) & (13) using screw (G) By screwdriver (not provided).



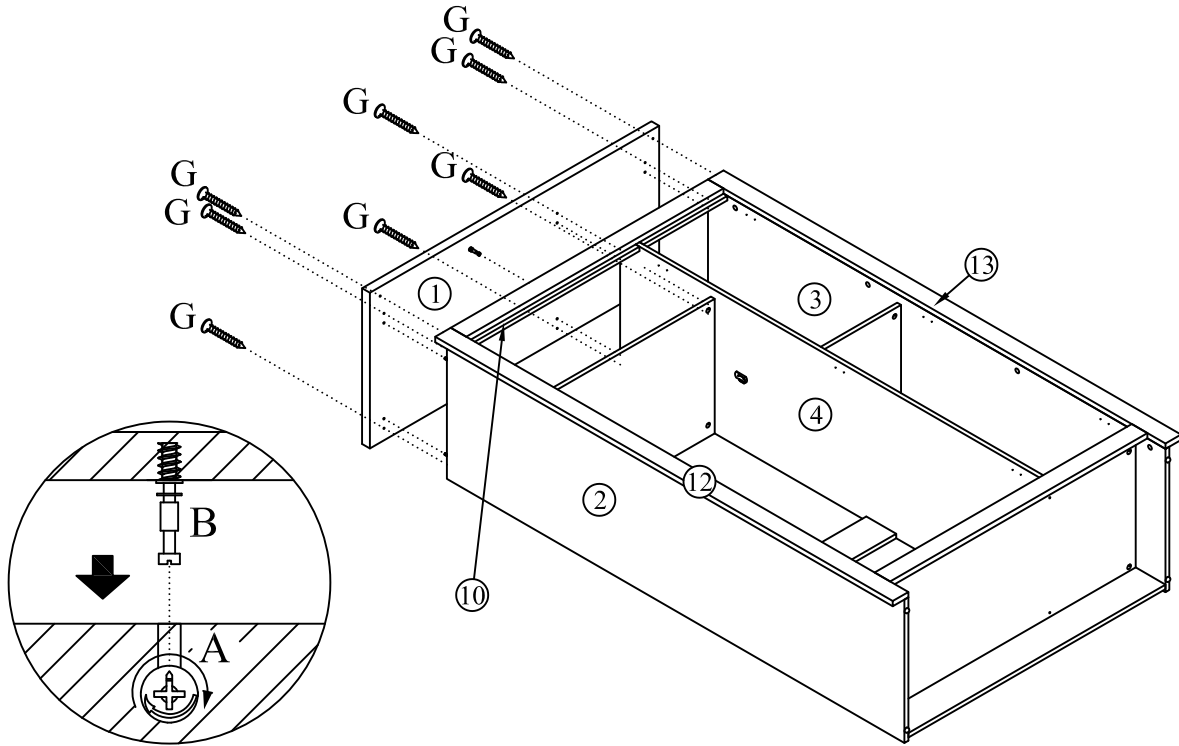

Vendor: S000398

Fix the Top panel (1) to Top Support Panel (10) by screwdriver (not provided).

DO NOT use any power tools as this may damage the frame and will invalidate any claim.



12

L		40
P		2
Q		2
R		2

Attach The Back Panel (17) & (18) using Nail (L) by screwdriver (not provided).



Fix Anti tip strap (Q) with washer (P) and Screw (R) To Top Panel (1) by screwdriver (not provided).

DO NOT use any power tools as this may damage the frame and will invalidate any claim.

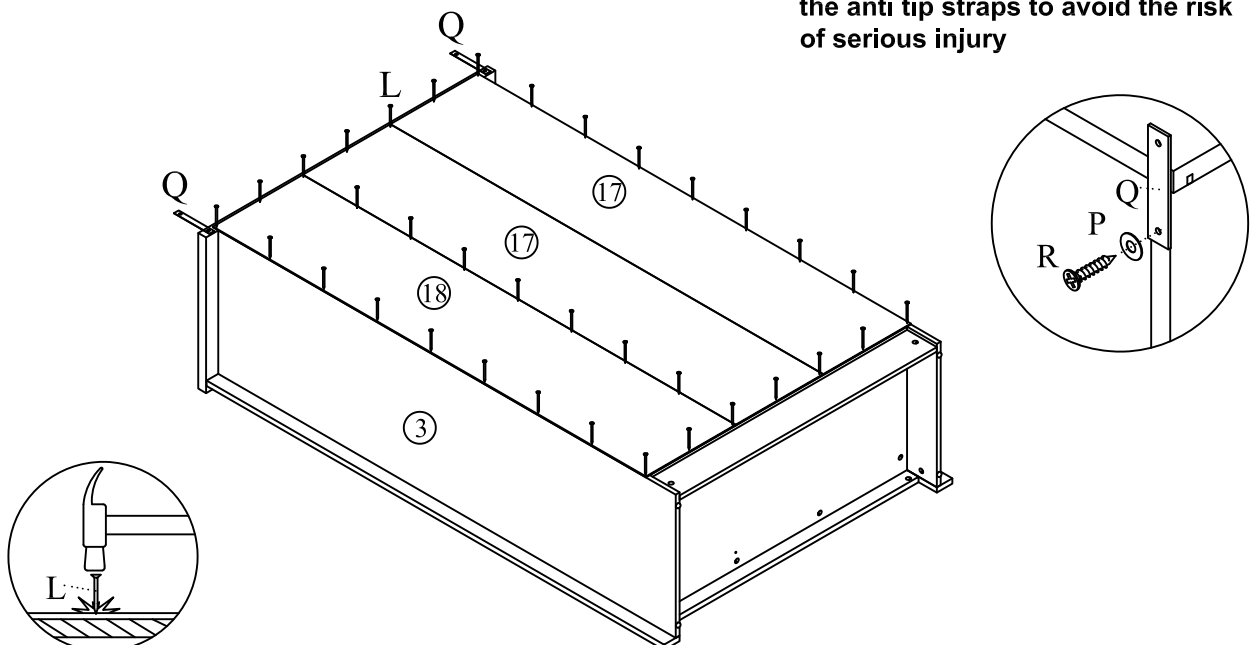
**\*\* We strongly recommend you use the anti tip straps to avoid the risk of serious injury**





13

E		18
I		6
S		3

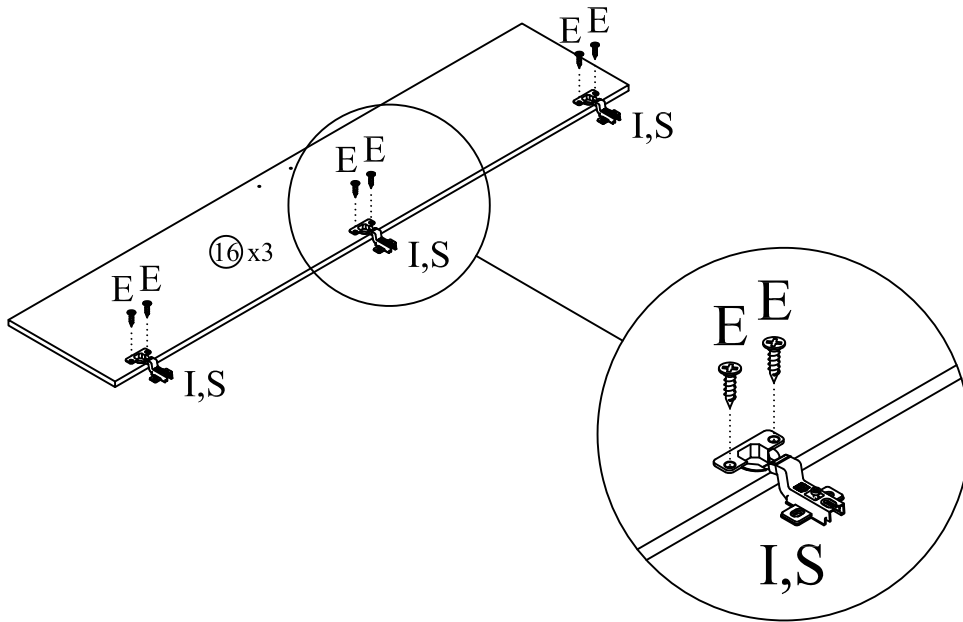
Fix hardware I & S with screw E using screwdriver (not provided).  
DO NOT use any power tools as this may damage the frame and will invalidate any claim. Vendor: S000398



14

E		18
N		1

Attach the Door (13) to Left, Right Panel (2), (3) and Center Panel (4) with Hinges (I) & (S) using screw (E) by screwdriver (not provided).  
DO NOT use any power tools as this may damage the frame and will invalidate any claim.

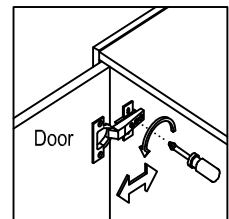
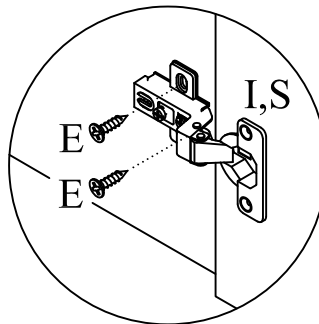
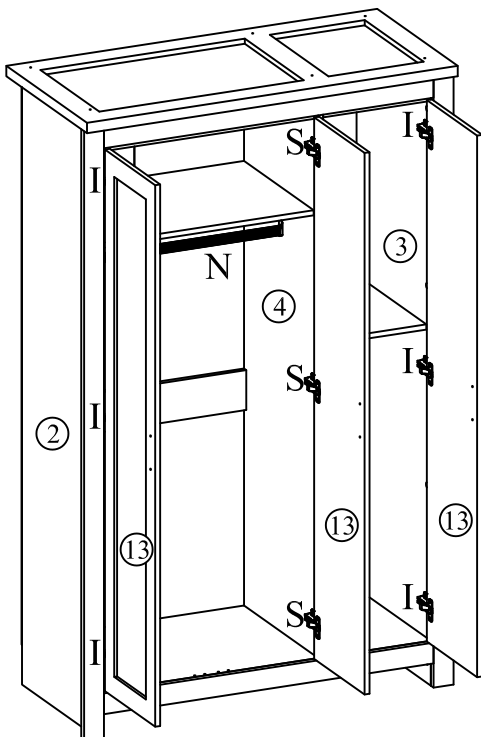

Front to back Adjustment

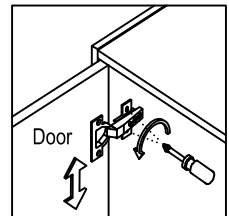

Vertical Adjustment

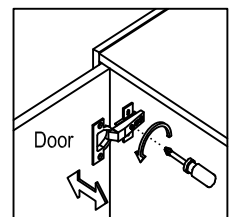

Left to right Adjustment

**\*\* Refer to page 10 to adjust hinges**

# TO ADJUST YOUR DOORS TO MAKE THE GAPS MORE EVEN (OPTIONAL).

## Step 14a

Adjust the door move in or out a little.

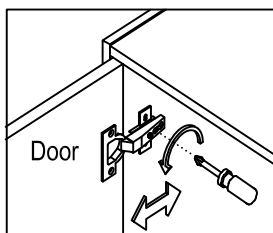

Loosen the screw indicated a little, adjust the hinge to right position (see step 23b & 23c), then tighten the screw.

## Step 14b

MOVE DOOR IN

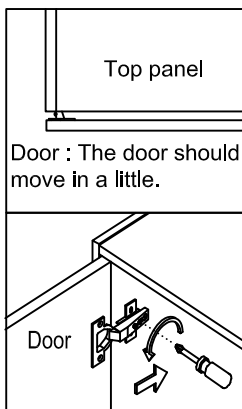

Push the hinge back a little.

## Step 14c

MOVE DOOR OUT

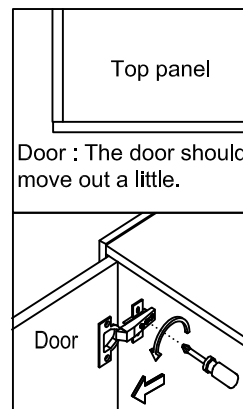

Push the hinge forward a little.

## Step 14d

To adjust the gap between door and side.

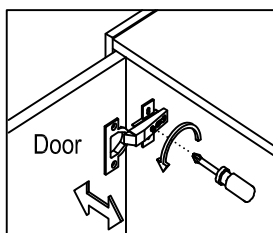

Loosen or tighten the screw indicated a little to adjust the gap between door and leg (see step 23e & 23f).

## Step 14e

MOVE DOOR RIGHT

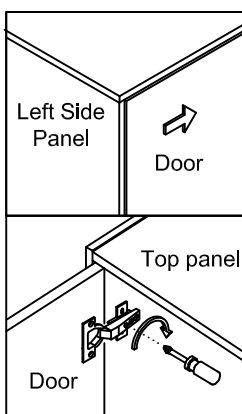

Turn the screw clockwise a little as shown to make the gap big.

## Step 14f

MOVE DOOR LEFT

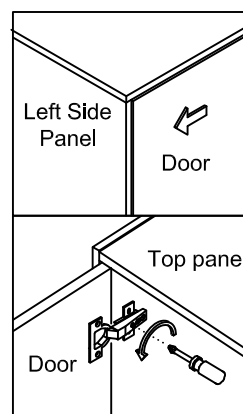

Turn the screw counterclockwise a little as shown to make the gap small.

## Step 14g

To adjust the gap between door and side.

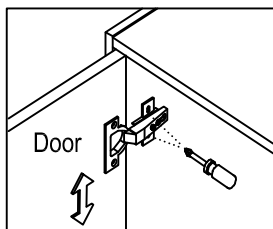

Loosen or tighten the screw indicated a little to adjust the door panel up & down (see step 23h).



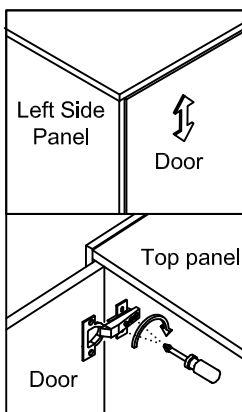

## Step 14h

MOVE DOOR UP & DOWN



Turn the screw clockwise a little and adjust the door panel up & down.

15

E		2
H		6
J		3
T		2

Fix Handle (J) to Door (13) using screw (H) by screwdriver (not provided).

Vendor: S000398

Fix Door Stopper (T) with Screw (E) To Bottom Panel (5) by screwdriver (not provided).  
DO NOT use any power tools as this may damage the frame and will invalidate any claim.

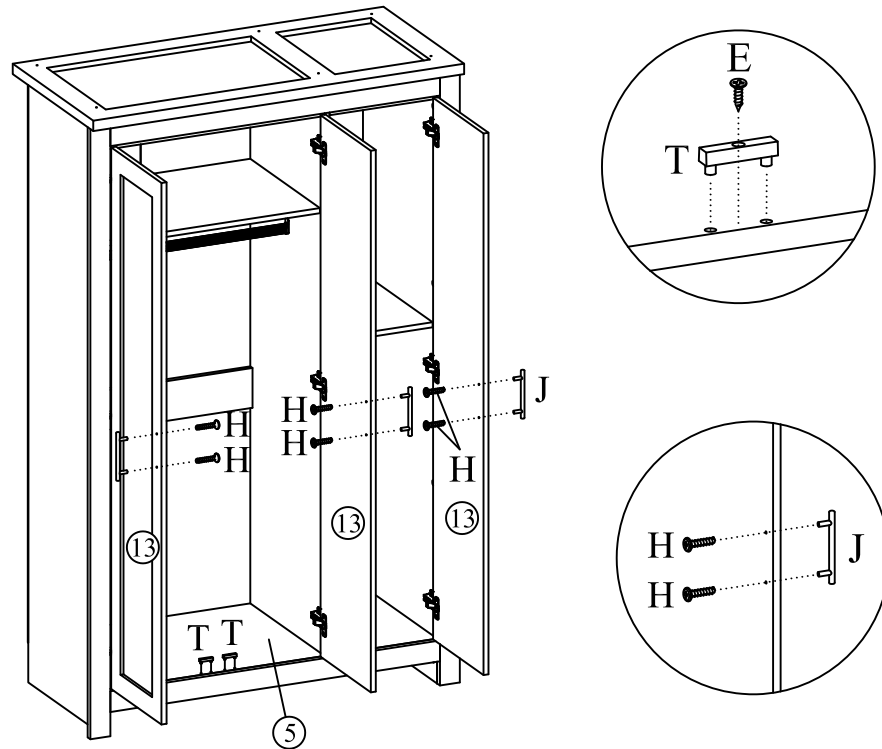

16

P		2
R		2

Fix Anti tip strap (Q) with washer (P) and Screw (R) to wall by screwdriver (not provided).  
- Make sure it is firmly attached and make sure it is snug fit.  
- Seek advice from a qualified trade person on how to attach this safety strap to your specific wall.

DO NOT use any power tools as this may damage the frame and will invalidate any claim.

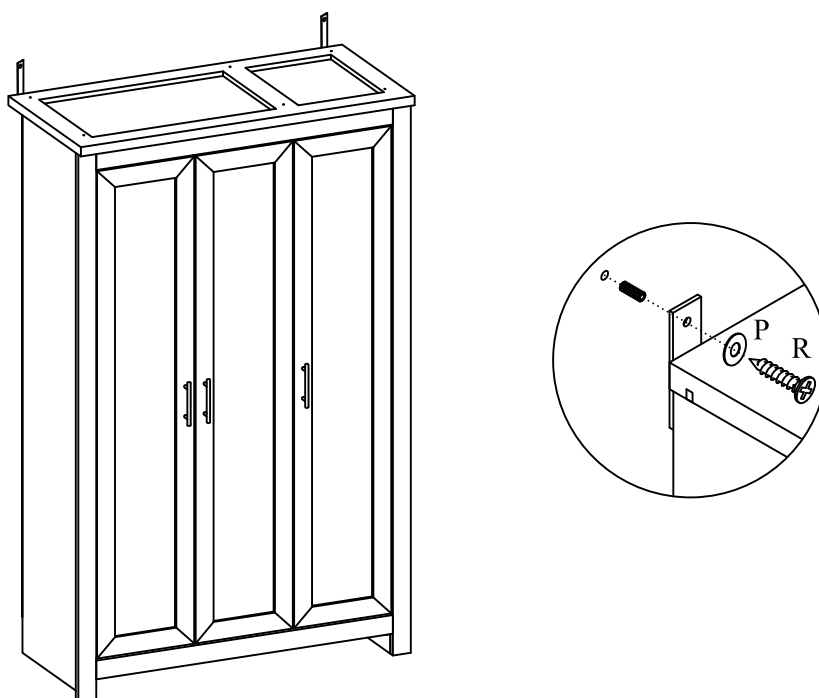

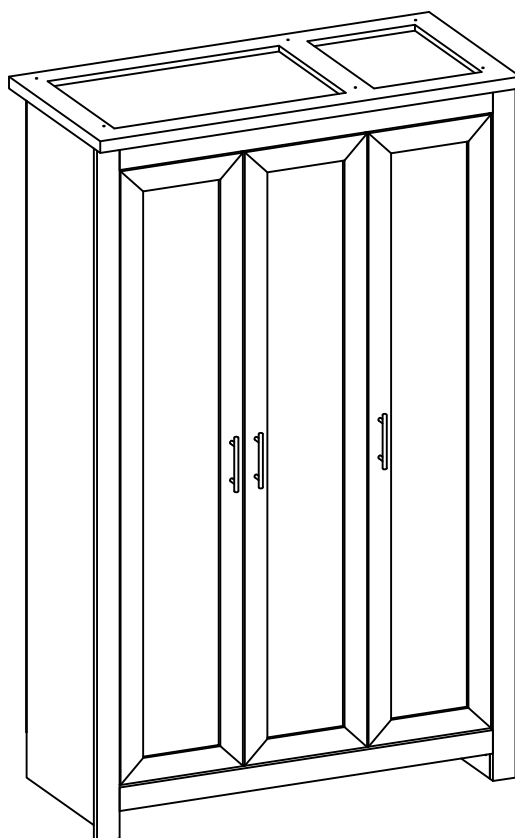

## WARNING!

In order to prevent overturning this product must be used the wall attachment device provided. Serious or fatal crushing injuries can occur from furniture tipping over. To help prevent topple over:-

- Use the wall attachment devices provided
- Never allow children to climb or hang on drawers or doors
- Do not overload the drawer beyond maximum recommended loading
- Place heaviest items in the lower drawers or shelves
- Unless specifically designed to accomodate, do not set TV's or other heavy objects on top of this product
- Never open more than one drawer at a time
- Do not hang things from the doors

An attachment device is provided with your product, however you will need to source suitable fixings for your wall type.

If in doubt consult a qualified trades person.

Always ensure that the wall to be drilled into is free from hidden electrical wire, water and gas pipe.

# Birlea®

.Additional Information:

.For complete product information, images and dimension diagrams please visit the website [www.birlea.com](http://www.birlea.com)

.If you have any issues with your item please contact the retailer directly you purchased it from who will be able to resolve any issues with Birlea.

.Why don't you send us photos of your assembled furniture to [info@birlea.com](mailto:info@birlea.com) to be shared in our #birleahome feature on Instagram.