

Birlea®

Assembly Instructions

Thank you for
purchasing a
Birlea product

For a chance to win a Love2Shop voucher simply post a picture of your new product on your preferred social channels tagging Birlea Furniture. One winner will be selected at random each month.

*Terms & conditions may apply.

Are you happy with your purchase?

Yes: That's great, we would love to hear more from you. Please leave us a review on our Trustpilot link on the QR code here. Your feedback will be greatly appreciated.



No: If for any reason there is something missing, indifferent or incorrect with your order, please contact the retailer that you purchased your item from.

Please note that this items build time is around 45 minutes.



www.birlea.com



ASSEMBLY INSTRUCTIONS HIGHGATE 2 DOOR WARDROBE

IMPORTANT: READ THESE INSTRUCTIONS CAREFULLY BEFORE ASSEMBLING OR USING YOUR HIGHGATE 2 DOOR WARDROBE .

PLEASE KEEP THESE INSTRUCTIONS FOR FUTURE REFERENCE.

HEALTH & SAFETY:

DO NOT use this item if any parts are missing, damaged or worn.

DO NOT use this item unless all fixings are secured.

Please keep small parts out of reach of children.

Always use on a level, even surface.

It is recommended that two people handle and assemble the item.

Birlea advise you use the wall straps provided to further enhance the safety of this product.

CARE & MAINTENANCE:

Assemble in the room of use.

To avoid damages assemble the item on a soft, clean surface

Periodically check all screws & fixings to ensure they are secure.

DO NOT push the item as this will damage the base.

Always lift the item with two people to reposition.

Keep any sharp objects away from the item.

This product is manufactured in pine which is a wood with natural characteristics including knots, grains, clusters or indentations.

On unpacking the item you may notice an odour due to production processes but this will disappear after a period of time.

DO NOT place the item next to a radiator or direct sunlight - this item is susceptible to temperature change. It is recommended an even room temperature be maintained with no sudden fluctuations.

DO NOT place hot or cold items directly onto the surface of the item as marking will occur

For general cleaning use a duster or damp cloth (almost dry) not wet - do not use soap and water, detergents, aerosol sprays or any polish as use of these materials would invalidate any claims.

DO NOT place the item onto wet or damp flooring as staining may occur to the floor.

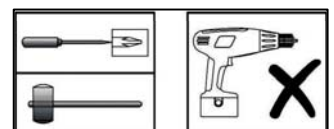
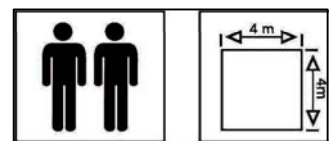
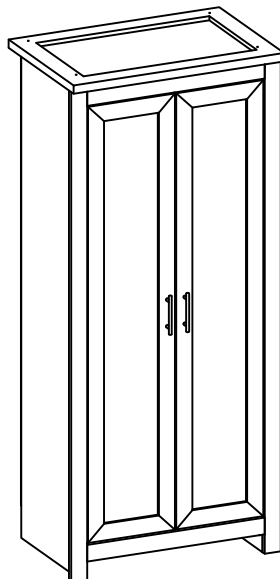

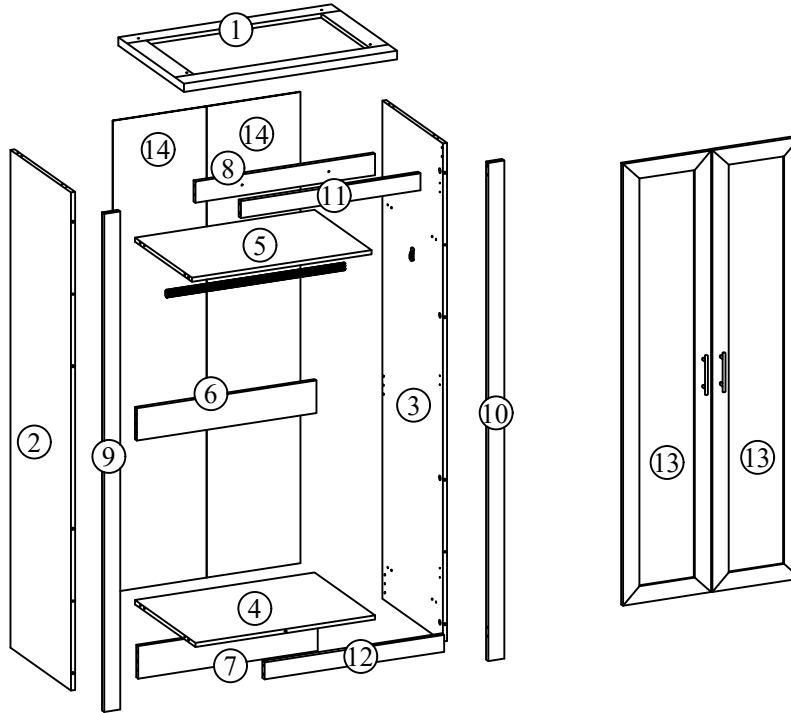



















PARTS LIST

Carton 1 of 2:

Part	Description	Qty
1	Top Panel	1
3	Right Panel	1
4	Bottom Panel	1
5	Fix Shelf Panel	1
6	Back Support Panel	1
7	Plinth Panel	1
8	Top Support Panel	1

HARDWARE LIST: Carton 1 of 2

Part	Description	Qty
A	CAM NUT 15mm 	26
B	CAM BOLT 	26
C	WOOD DOWEL M6 x 25mm 	32
D	COUNTERSUNK SCREW M3.5 x 12mm 	4
E	COUNTERSUNK SCREW M4 x 16mm 	26
F	COUNTERSUNK SCREW M4 x 25mm 	2
G	COUNTERSUNK SCREW M4 x 65mm 	6
H	SCREW M4 x 22mm 	4
I	HINGES 7/8" 	6
J	METAL BAR HANDLE 96mm 	2
K	PVC NAIL 	4
L	NAIL 	30
M	OVAL BRACKET 	2
N	OVAL PIPE (657mm) 	1
O	WASHER (M4) 	4
P	ANTI TIP STRAP 	2
Q	COUNTERSUNK SCREW M4 x 20mm 	4
R	DOOR STOPPER 	2

PARTS LIST

Carton 2 of 2:

Part	Description	Qty
2	Left Panel	1
9	Left Post Panel	1
10	Right Post Panel	1
11	Top Post Panel	1
12	Bottom Post Panel	1
13	Door	2
14	Back Panel	2

** You will need a screwdriver and a small mallet (NOT provided)

Measure Tape

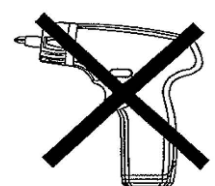

** WARNING: THE USE OF POWER TOOLS TO ASSEMBLE THIS PRODUCT WILL INVALIDATE ANY CLAIM AND MAY DAMAGE THIS PRODUCT MAKING IT UNSAFE.

1

A		4
B		13
C		4

Insert hardware part A & part B using a screwdriver (not provided).
Insert hardware part C using a small mallet (not provided).

Vendor: S000398

DO NOT use any power tools as this may damage the frame and will invalidate any claim.

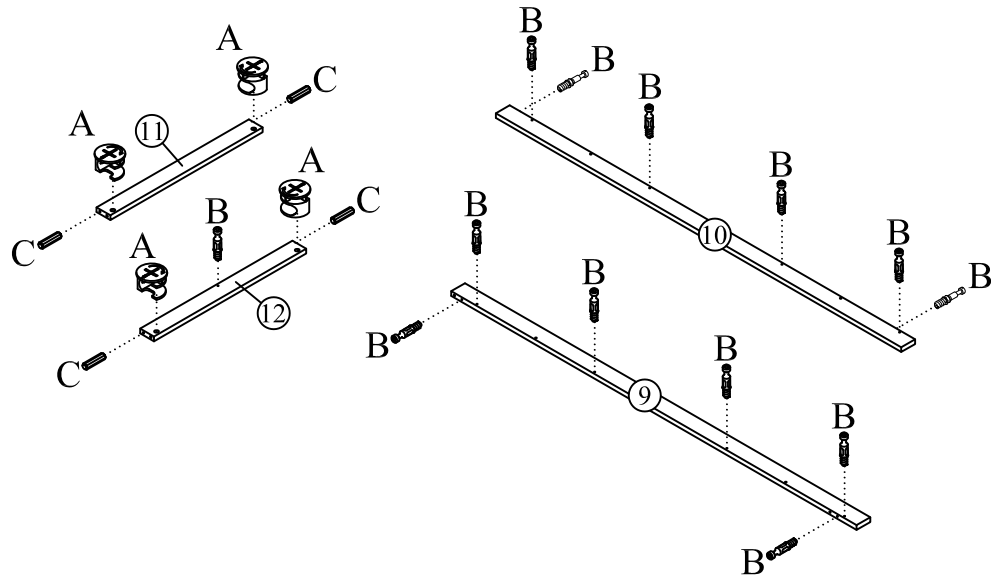





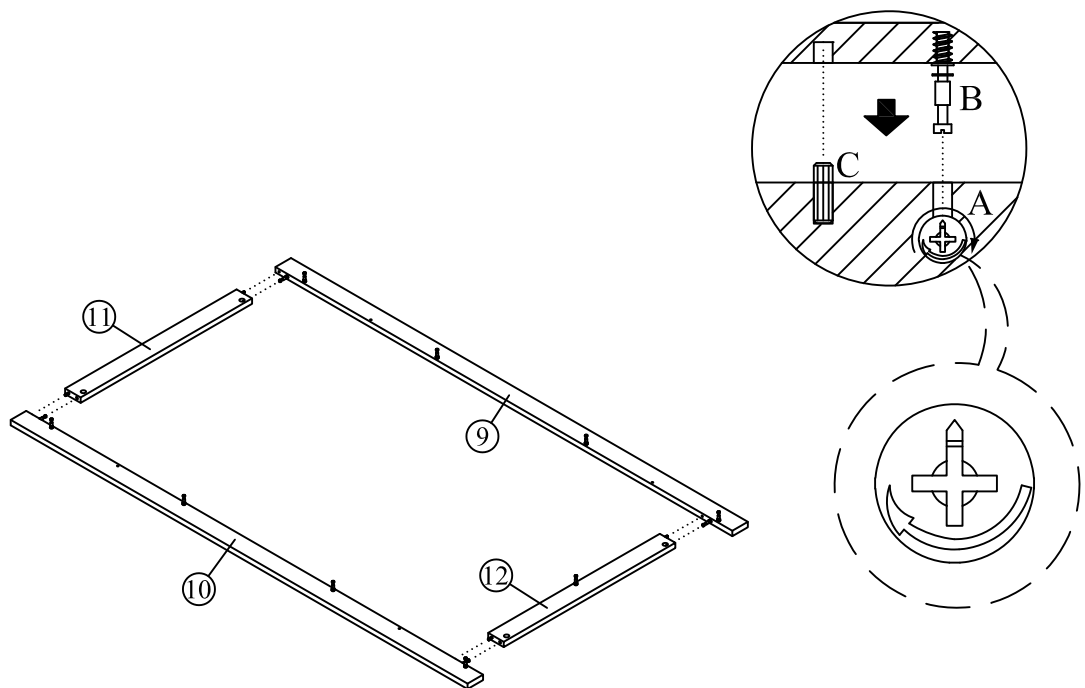

2

Attach the Post Panel together (9),(10),(11)&(12) by screwdriver (not provided).

DO NOT use any power tools as this may damage the frame and will invalidate any claim.



3	A		18
	B		6
	C		24
	D		2
	K		2
	M		1

Insert hardware part A & part B using a screwdriver (not provided).
 Insert hardware part C using a small mallet (not provided).
 Insert hardware part K using a small mallet (not provided).
 Fix hardware I with screw E using screwdriver (not provided).
 Fix hardware M with screw D using screwdriver (not provided).
DO NOT use any power tools as this may damage the frame and will invalidate any claim.

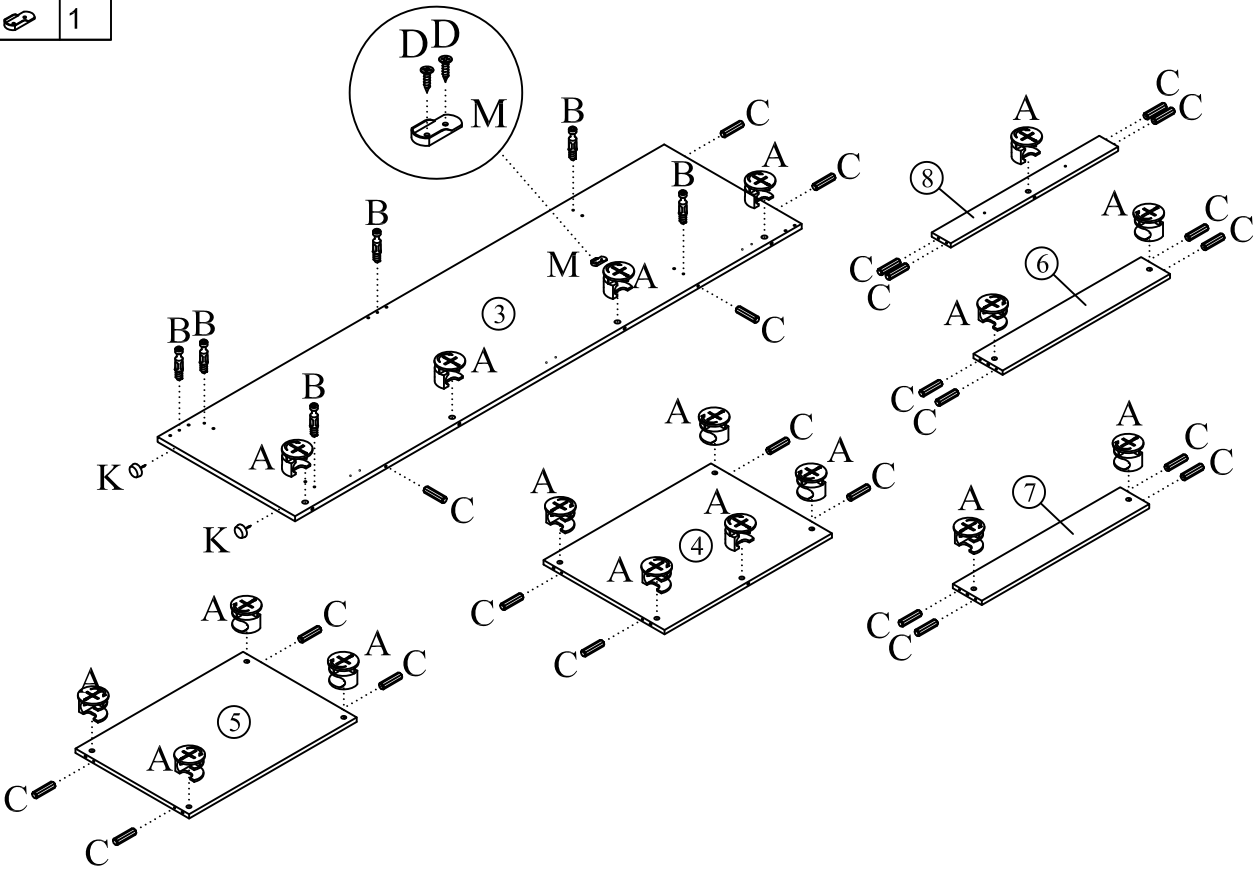

4 Attach the Bottom Panel(4) , Fix Shelf Panel (5) , Plinth Panel (7) Top and Back Support Panel (6) & (8) to Right Panel (3) by screwdriver (not provided).
DO NOT use any power tools as this may damage the frame and will invalidate any claim.

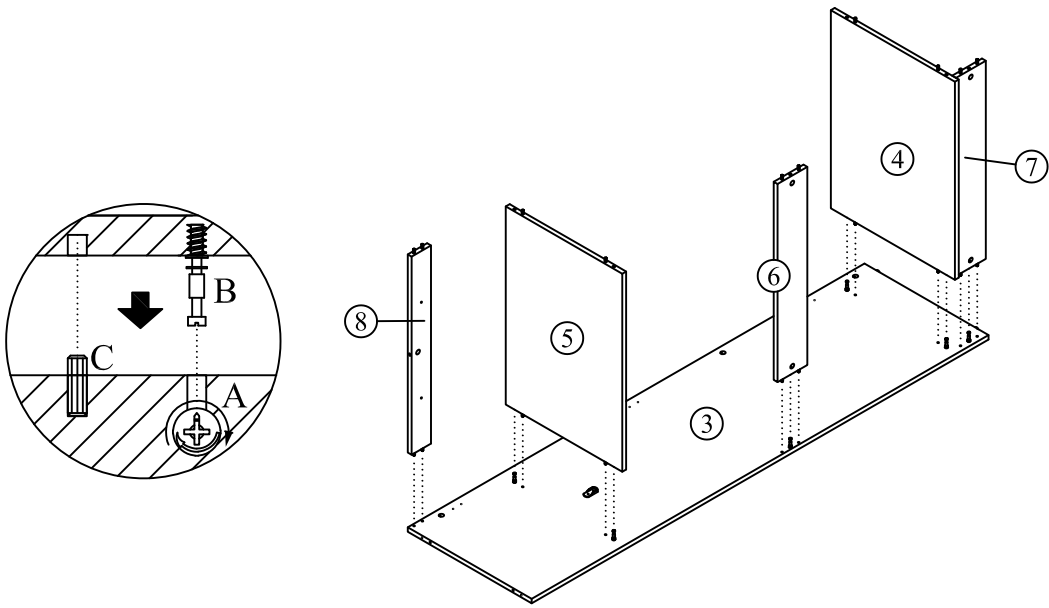

5	A		4
	B		6
	C		4
	D		2
	K		2
	M		1

Insert hardware part A & part B using a screwdriver (not provided).
 Insert hardware part C using a small mallet (not provided).
 Insert hardware part K using a small mallet (not provided).
 Fix hardware M with screw D using screwdriver (not provided).
DO NOT use any power tools as this may damage the frame and will invalidate any claim.

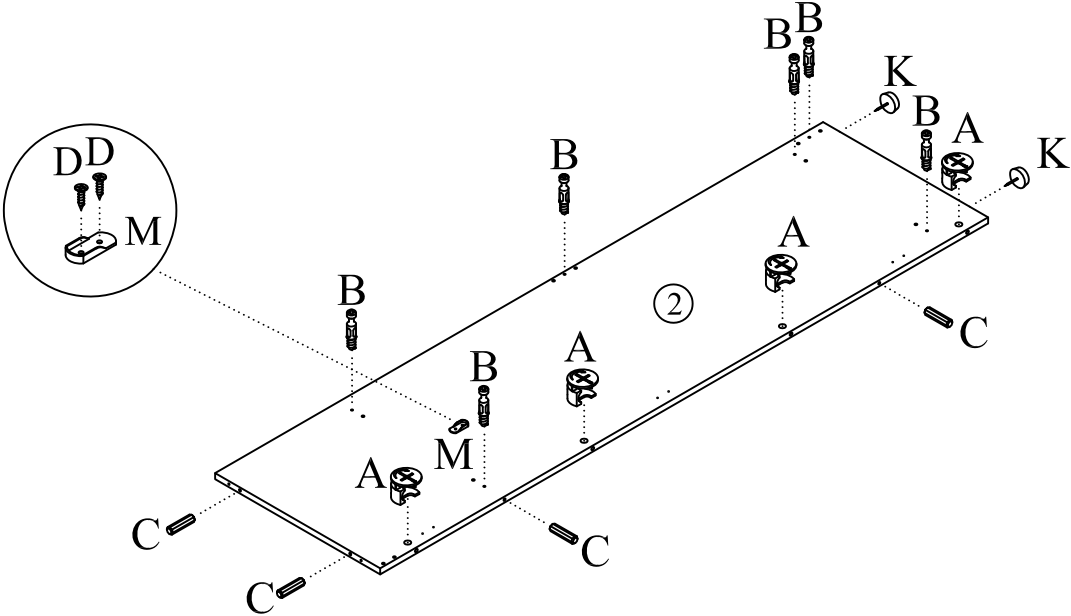

6 Attach the Left Panel (2) to Bottom Panel (4) , Fix Shelf Panel (5) , Plinth Panel (7) Top and Back Support Panel (6) & (8) by screwdriver (not provided).
DO NOT use any power tools as this may damage the frame and will invalidate any claim.

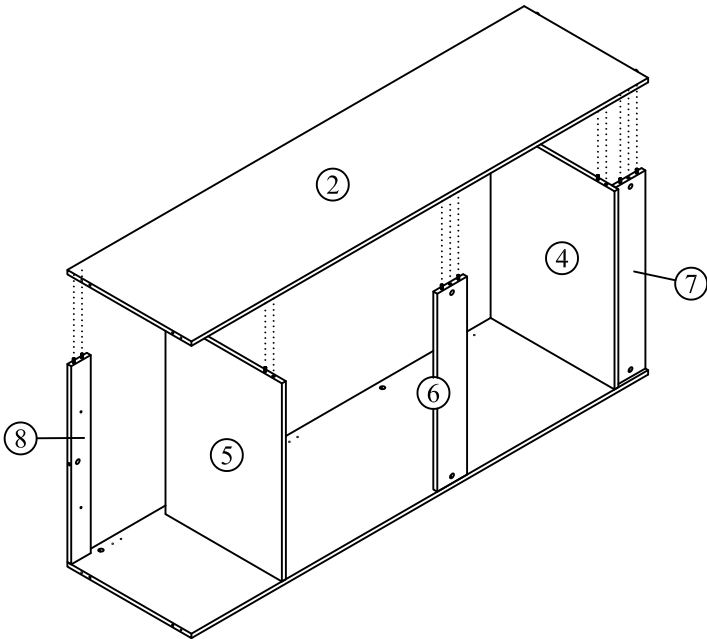
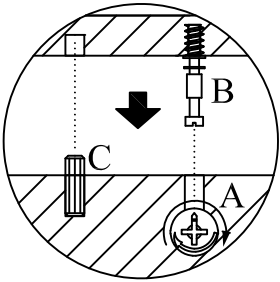

7

F		2
---	-----------------------------------------------------------------------------------	---

Attach ALL Post Panel (9) , (10) , (11) & (12) to Left , Right & Bottom Panel (2) ,(3) & (4) by screwdriver (not provided).

Fix Top Support Panel (8) to Top Post Panel (11) using screw (F) by screwdriver (not provided).

DO NOT use any power tools as this may damage the frame and will invalidate any claim.

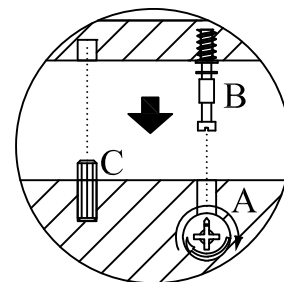
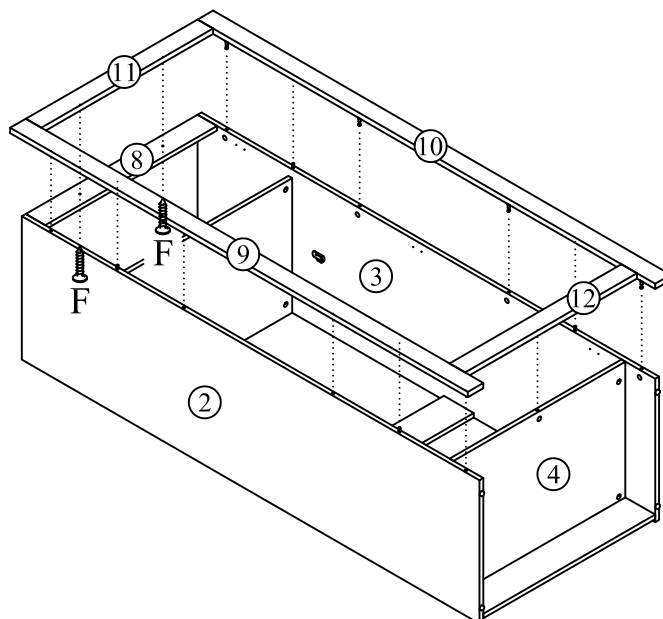
8

B		1
---	-------------------------------------------------------------------------------------	---

Insert hardware part B using a screwdriver (not provided).

DO NOT use any power tools as this may damage the frame and will invalidate any claim.

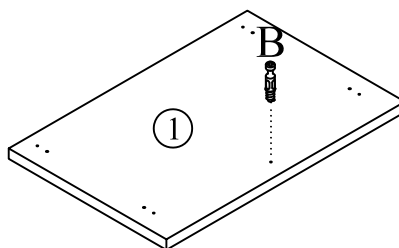



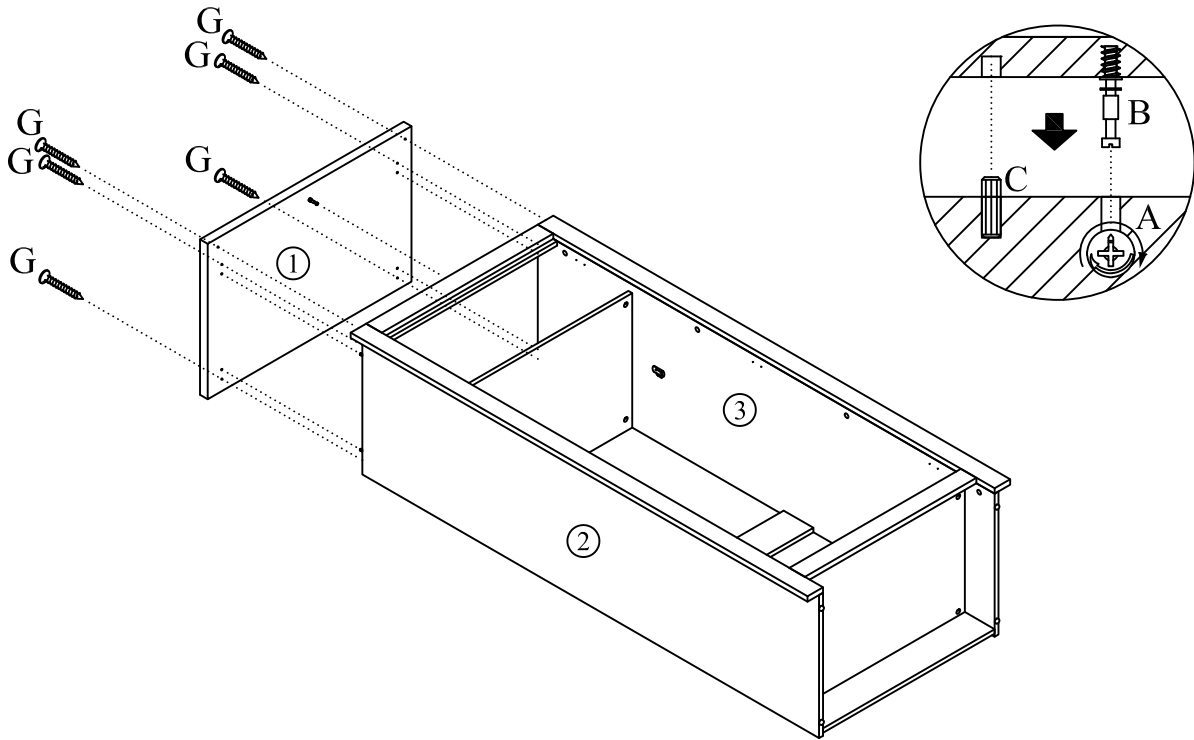

9

G		6
---	-----------------------------------------------------------------------------------	---

Attach the Top Panel (1) to Left , Right Panel (2) & (3) and Left and Right Post Panel (9) & (10) using screw (G) By screwdriver (not provided). Fix the Top panel (1) to Top Support Panel (8) by screwdriver (not provided). DO NOT use any power tools as this may damage the frame and will invalidate any claim. Vendor: S000398



10

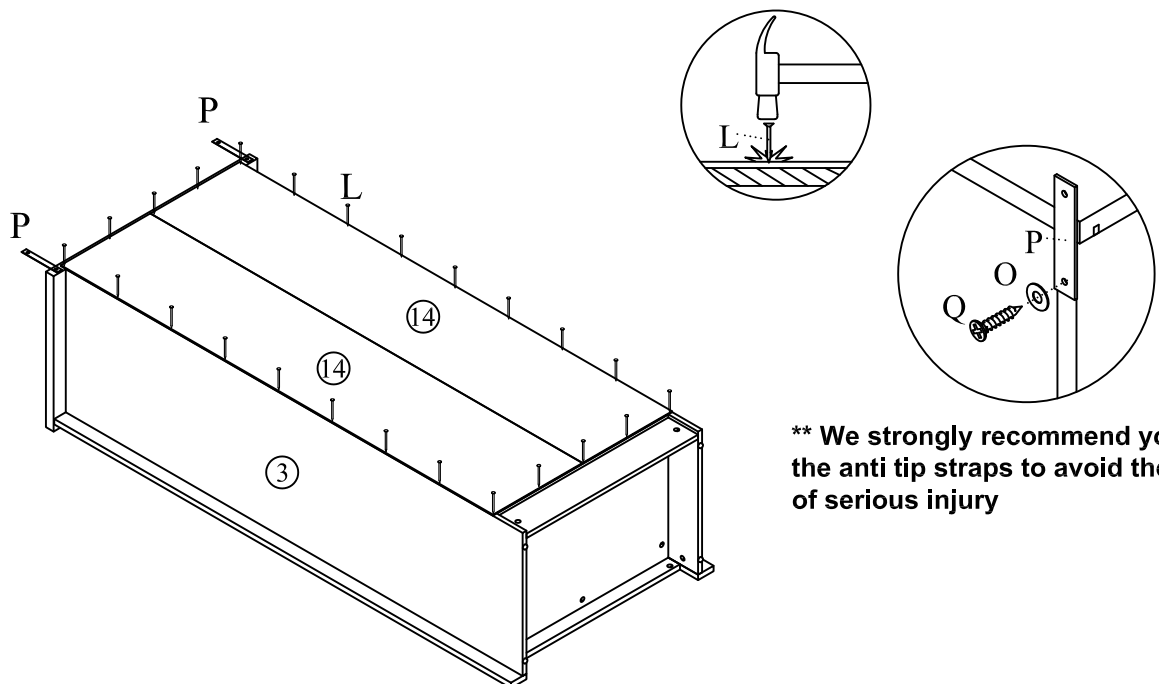

L		30
O		2
P		2
Q		2

Attach The Back Panel (14) using Nail (L) by screwdriver (not provided). Fix Anti tip strap (P) with washer (O) and Screw (Q) To Top Panel (1) by screwdriver (not provided). DO NOT use any power tools as this may damage the frame and will invalidate any claim.



**** We strongly recommend you use the anti tip straps to avoid the risk of serious injury**

11

E		12
I		6

Fix hardware I with screw E using screwdriver (not provided).
DO NOT use any power tools as this may damage the frame and will invalidate any claim.

Vendor: S000398

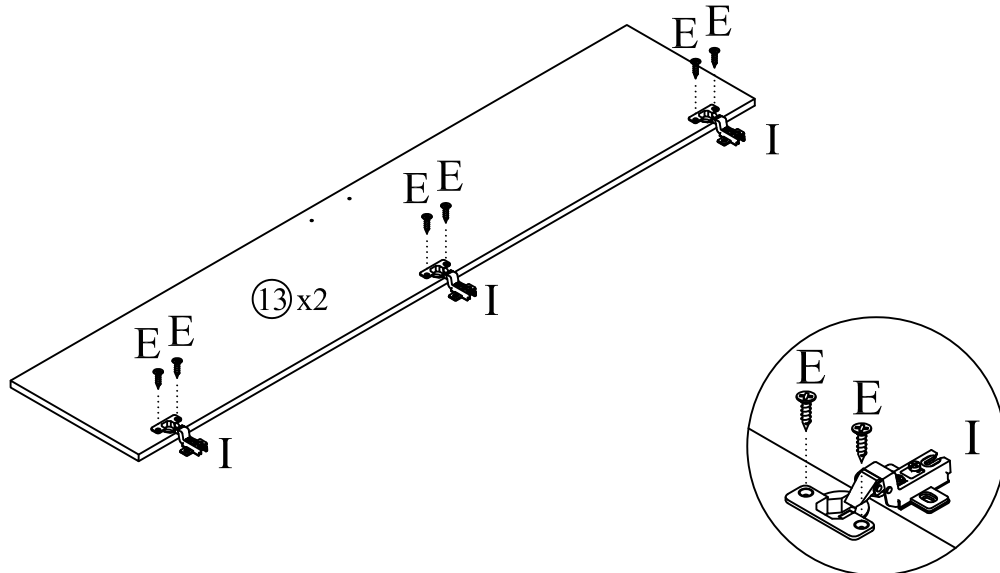
**12**

E		12
---	-------------------------------------------------------------------------------------	----

Attach the Door (13) to Left and Right Panel (2) & (3) with Hinges (I) using screw (E) by screwdriver (not provided).

DO NOT use any power tools as this may damage the frame and will invalidate any claim.

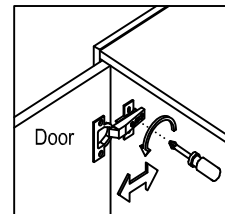
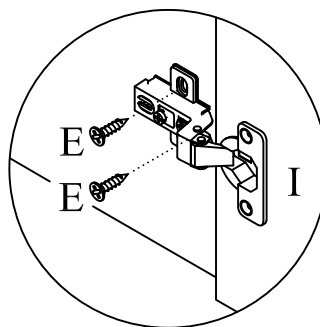
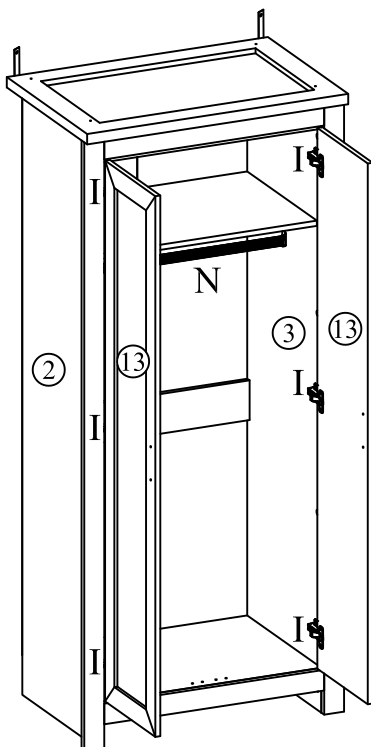

Front to back Adjustment

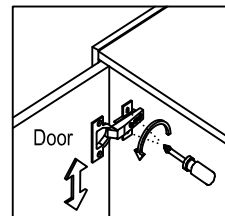

Vertical Adjustment

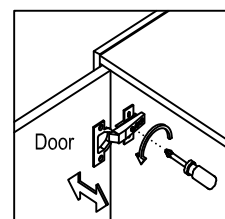

Left to right Adjustment

**** Refer to page 9 to adjust hinges**

Page 8 of 11

TO ADJUST YOUR DOORS TO MAKE THE GAPS MORE EVEN (OPTIONAL).

Step 12a

Adjust the door move in or out a little.

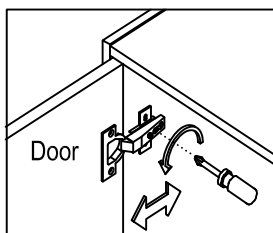

Loosen the screw indicated a little, adjust the hinge to right position (see step 23b & 23c), then tighten the screw.

Step 12b

MOVE DOOR IN

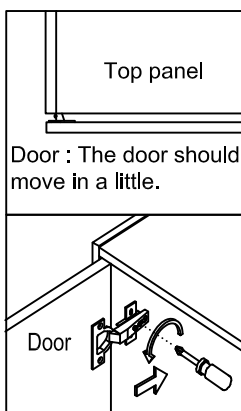

Door : The door should move in a little.

Push the hinge back a little.

Step 12c

MOVE DOOR OUT

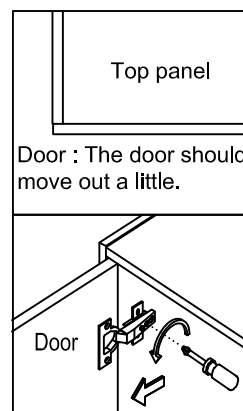

Door : The door should move out a little.

Push the hinge forward a little.

Step 12d

To adjust the gap between door and side.

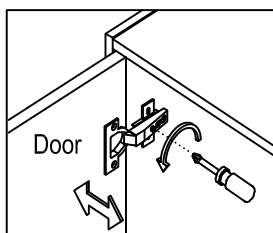

Loosen or tighten the screw indicated a little to adjust the gap between door and leg (see step 23e & 23f).

Step 12e

MOVE DOOR RIGHT

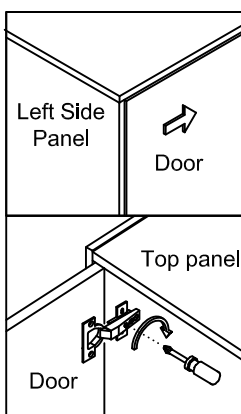

Turn the screw clockwise a little as shown to make the gap big.

Step 12f

MOVE DOOR LEFT

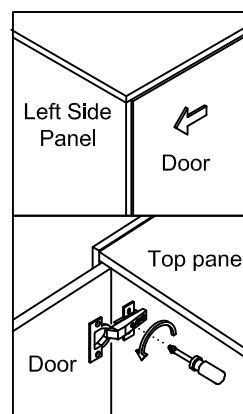

Turn the screw counterclockwise a little as shown to make the gap small.

Step 12g

To adjust the gap between door and side.

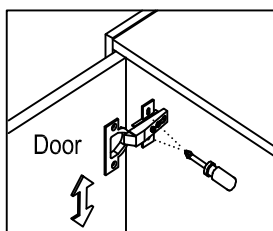

Loosen or tighten the screw indicated a little to adjust the door panel up & down (see step 23h).





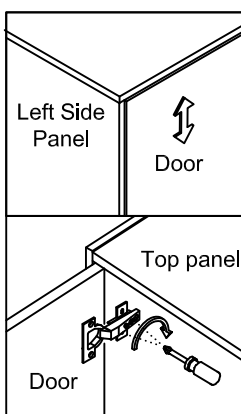

Step 12h

MOVE DOOR UP & DOWN



Turn the screw clockwise a little and adjust the door panel up & down.

13

E		2
H		4
J		2
O		2
Q		2
R		2

Vendor: S000398
 Fix Handle (J) to Door (13) using screw (H) by screwdriver (not provided).
 Fix Door Stopper (R) with Screw (E) to Bottom Panel by screwdriver (not provided).
 A wall attachment strap is provided with your product, however you will need to secure suitable fixings to secure to your wall type.
 If in doubt consult a qualified trades person.
 Always ensure that the wall drilled into is free from hidden electrical wire, water and gas pipes.
DO NOT use any power tools as this may damage the frame and will invalidate any claim.

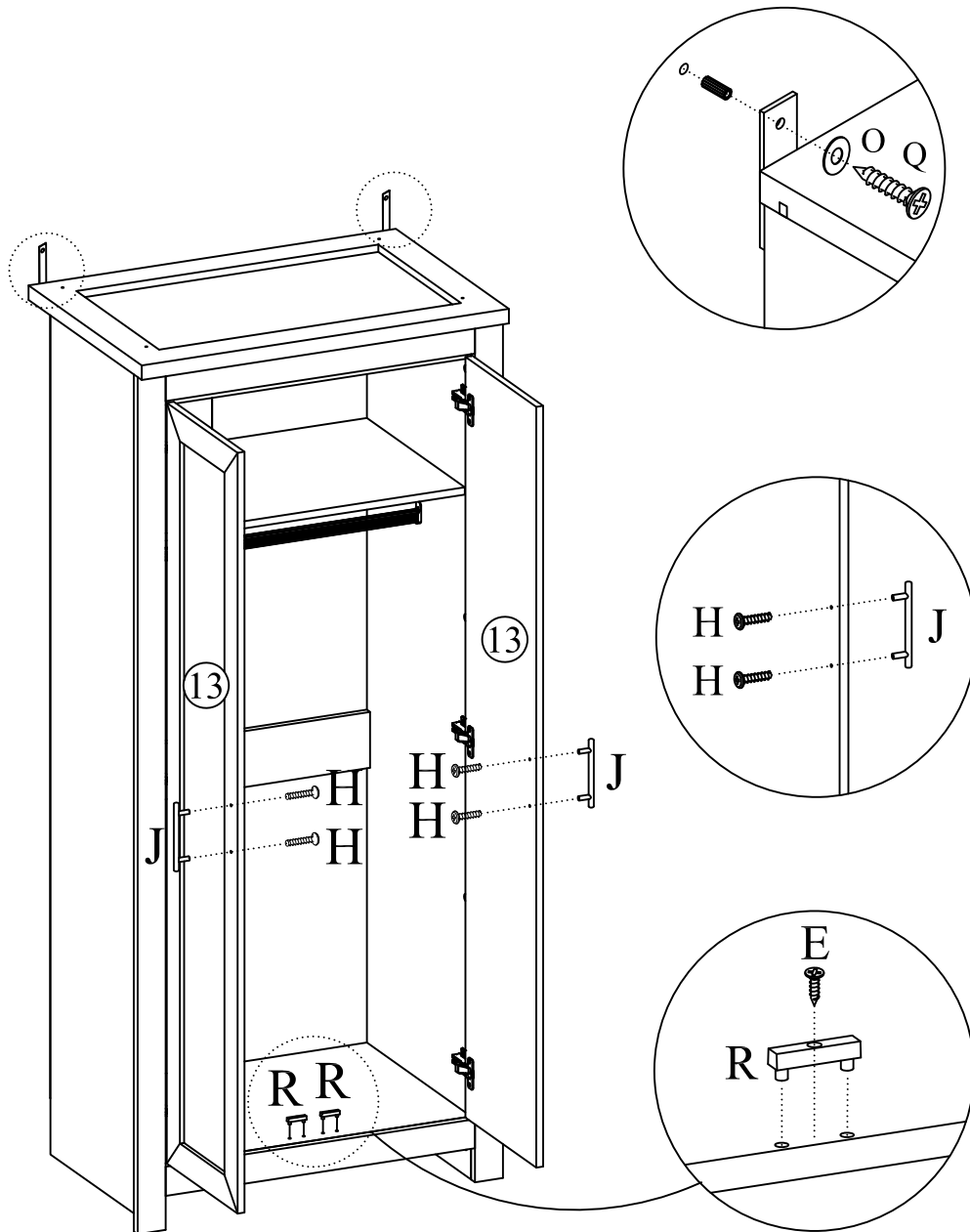

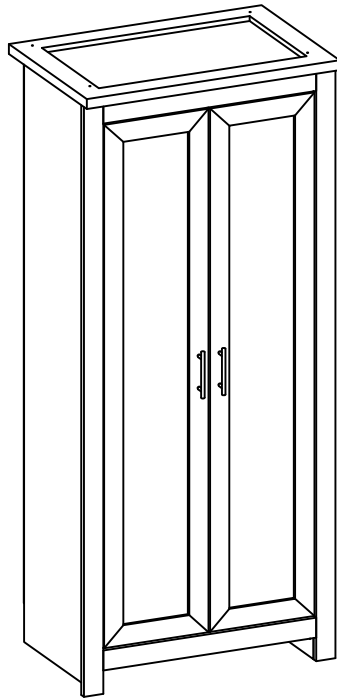

WARNING!

In order to prevent overturning this product must be used the wall attachment device provided. Serious or fatal crushing injuries can occur from furniture tipping over. To help prevent topple over:-

- Use the wall attachment devices provided
- Never allow children to climb or hang on drawers or doors
- Do not overload the drawer beyond maximum recommended loading
- Place heaviest items in the lower drawers or shelves
- Unless specifically designed to accomodate, do not set TV's or other heavy objects on top of this product
- Never open more than one drawer at a time
- Do not hang things from the doors

An attachment device is provided with your product, however you will need to source suitable fixings for your wall type.

If in doubt consult a qualified trades person.

Always ensure that the wall to be drilled into is free from hidden electrical wire, water and gas pipe.

Birlea.

.Additional Information:

.For complete product information, images and dimension diagrams please visit the website www.birlea.com

.If you have any issues with your item please contact the retailer directly you purchased it from who will be able to resolve any issues with Birlea.

.Why don't you send us photos of your assembled furniture to info@birlea.com to be shared in our #birleahome feature on Instagram.