

BEFORE YOU GET STARTED...

We're confident you'll love your gorgeous new Next furniture. However, it's worth making absolutely certain before you put it all together.

So, let's quickly run through these three steps:

1. COLOUR

Make sure you're happy with the colour
No need to unpack everything, just check the first component.

2. PROTECTIVE PACKAGING

If you're happy, then it's time to get opening! Start by laying everything out on the protective packaging – this will prevent anything getting scratched.

3. PARTS PAGE

Finally, double check you have all the pieces by referencing the parts page of the instructions.

TIPS FOR RETURNS

Not completely happy with the product? No problem. We just need everything back in the original packaging, so follow the steps below and this will ensure a super-smooth returns process and no delay to your refund.

DO



- Check everything is there (the 'parts page' is a handy checklist).
- Pop all the loose fittings and fixtures into the packaging provided or tie them up in a plastic bag.
- Wrap all the big components back up in the original protective packaging.
- Close up the box and seal it securely (don't be afraid to use plenty of tape).

DON'T



- Leave anything assembled - all components should be dismantled and separately packed.
- Put loose fixtures and fittings straight into the box.
- Throw it back in the box carelessly – as it may get damaged.

next
HOME

Then just give us a call on 0333 777 8999 and we'll sort out a pick up time for you.

next

Storage Stool

Assembly instructions

Actual product size:
H45 x W38 x D38cm

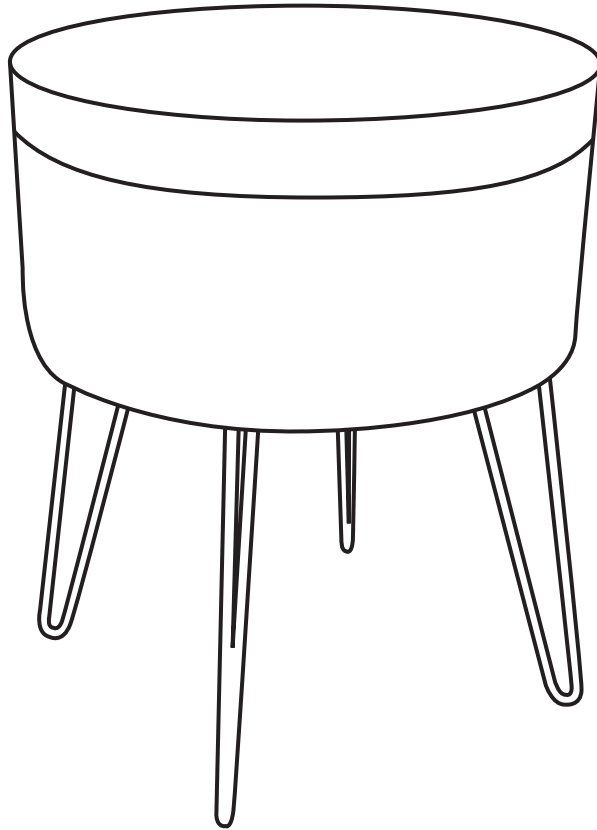

ITEM	COLOUR	COMPOSITION
570067	TEAL VELVET	100% POLYESTER
574015	PLUM VELVET	100% POLYESTER
547658	NAVY VELVET	100% POLYESTER
555341	BLUSH VELVET	100% POLYESTER
567176	STEEL VELVET	100% POLYESTER
328777	BLUSH VELVET	100% POLYESTER
302166	NAVY VELVET	100%POLYESTER
651031	COSY VALAIS OCHRE	100%POLYESTER
395168	MINT VELVET	100%POLYESTER
749625	OCHRE VELVET	100%POLYESTER
372287	FINE CHENILLE LIGHT GREY	100%POLYESTER
M17021	MONZA PERPPERCORN	100%POLYESTER
M17698	OLIVE VELVET	100%POLYESTER

Need Help?

With: Assembly instructions
Missing or damaged parts

CALL: 0333 777 8999

IMPORTANT — RETAIN FOR FUTURE REFERENCE

BEFORE YOU START

Warnings

We suggest you retain these instructions for future reference.

Keep fittings out of children's reach and keep children well away from construction area.

This product should only be used on firm, level ground.

Please periodically check all fittings and re-tighten as necessary.

Please do not stand on your furniture.

Avoid exposing the furniture to excessive heat or direct sunlight as this can cause deterioration of the colour.

Do's

We suggest you spend a short time reading through this leaflet before you start.

When you are ready to start, make sure that you have the right tools, plenty of space.

Due to the size of this product we recommend that it is assembled in the room intended for use.

Unwrap all packaging materials and place the components on a clean surface to protect them from damage.

We recommend that the packaging is used to protect the surfaces during assembly.

Carefully check that you have all the parts before beginning assembly.

Ensure the product is fully assembled as illustrated and all fixings are fully tightened before use. Check fixings regularly to ensure they remain tight.

When moving your assembled bed. It is best to lift the bed and never to drag it. Please check that the centre support rail is securely fixed in place.

Never allow any kind of liquid to remain on your furniture. Absorption can cause materials to warp or finishes to de-laminate.

To clean your item, please use a vacuum or lightly brush clean.

Don'ts

Do not tighten screws until fully assembled.

Do not over tighten screws or bolts.

Do not drag or pull your furniture.

Do not use this product if parts are missing, damaged or worn.

Never use scourers, abrasives or chemical cleaners.

Number of people required to assemble

One person is required to assemble this item



Time to assemble



15min

Missing parts

If you are missing any fixtures and fittings for your product please contact our customer service team on **0333 777 8999** and they will be happy to arrange for a replacement to be sent to you free of charge.

Home service technicians

If you have a fault with your product please contact our customer service team on **0333 777 8999**. If you have had the product for 28 days or less you may be offered a replacement, refund or for a fully trained home service technician to visit your home to assess the fault and repair the product where possible. If you have had the product for more than 28 days we will send an independent home service technician to review and repair the product where possible and recommend further action.

You can write to us at

Home Customer Services
Next Retail Ltd,
Desford Road,
Leicester,
LE19 4AT,

To view our full furniture range please visit www.next.co.uk

GETTING TO KNOW YOUR PRODUCT

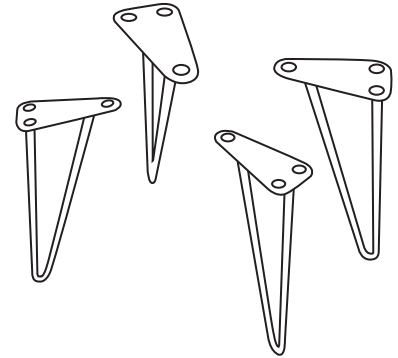
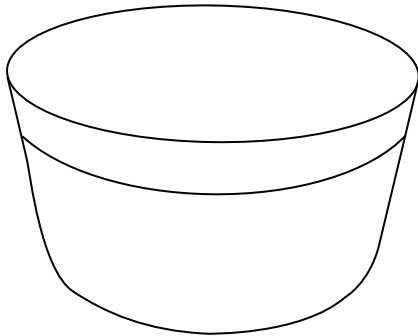

Components supplied. Please use this guide if you require replacement parts.

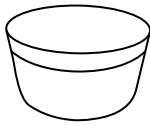
Ref	Description	Visual	Qty	Ctn
1	Storage Stool		1	1

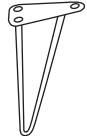
Ref	Description	Visual	Qty	Ctn
2	Legs		4	1

Fixtures and fittings supplied (actual size)

Ref	Dimensions	Qty	Spare
A	M6x12	12	1
B	M6	1	N/A

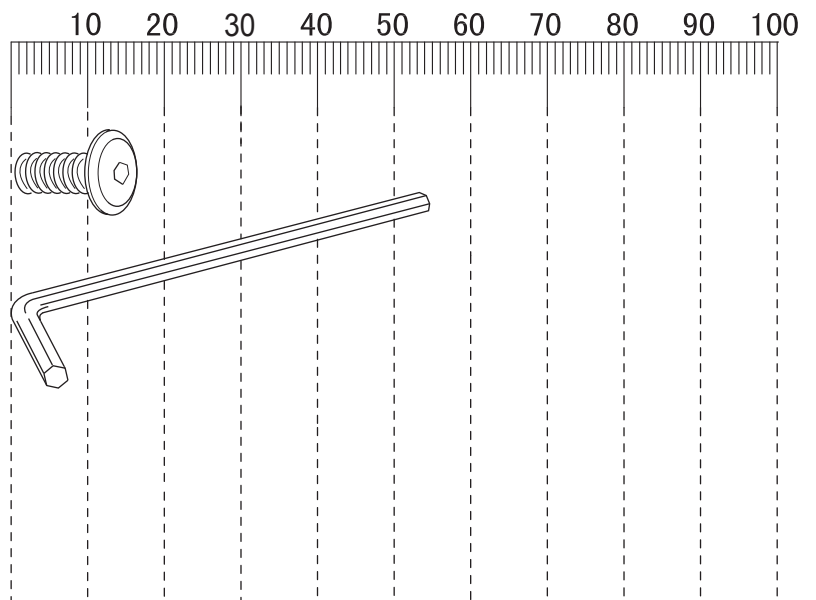

1

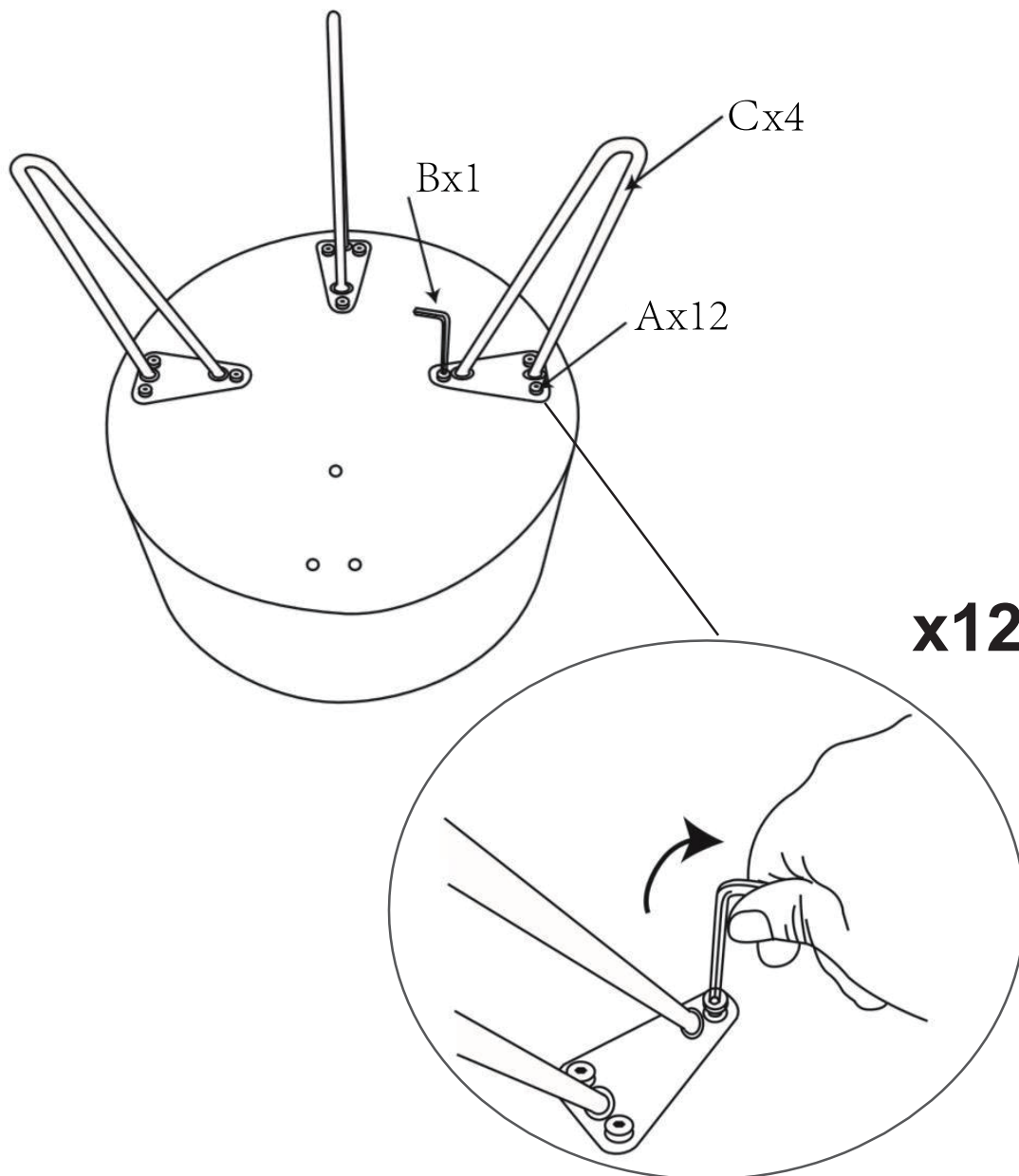

A x 12



