

NEXT

SIERRA SWIVEL CHAIR

Assembly instructions

Actual product size
H93xW74xD92.5CM

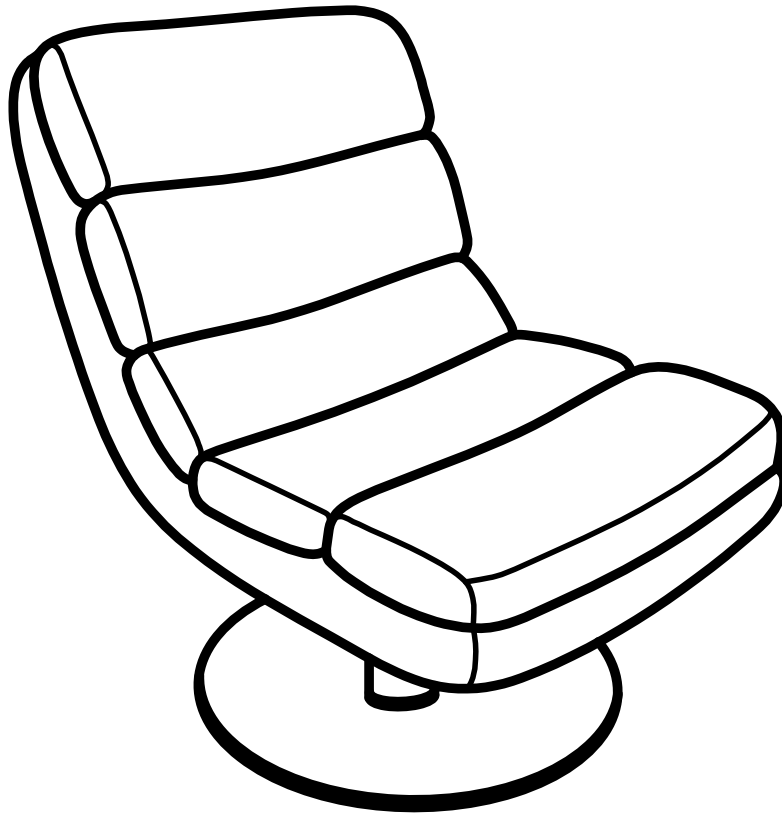

Item number	Fabric name-Base	Fabric composition
W66562	Soft Velvet Cranberry Red with Black Metal	100% polyester
W78603	Smart Chenille Light Natural with Chrome Metal	100% polyester

IMPORTANT RETAIN FOR FUTURE REFERENCE

Need Help?

With: Assembly instructions
Missing or damaged parts
CALL: 0333 777 8999

SIERRA SWIVEL CHAIR

Assembly instructions

BEFORE YOU START

Number of people required to assemble

One people are required to assemble this item

Time to assemble: 15 minutes



Do's

We suggest you spend a short time reading through this leaflet before you start.

When you are ready to start, make sure that you have the right tools and space.

Unwrap all packaging materials and place the components on a clean surface to protect it from damage,

We recommend that the packaging is used to protect the surfaces during assembly.

Carefully check that you have all the parts before beginning assembly. Ensure the product is fully assembled as illustrated and all fixings fully tightened before use. Check fixings regularly to ensure they remain tight. Always wipe dry after cleaning.

For the PU chairs, please lightly brush clean or lightly wipe with a slightly dampened cloth. Keep away from strong heat sources. Occasional overall cleaning should be carried out approximately once a month by using a slightly damp-ened soft cloth. Then buff with a dry clean soft cloth.

Don'ts

Never allow any kind of liquid to remain on your furniture. Absorption can cause wood to warp or finishes to de-laminate.

Do not stand or lean back on your chairs.

Do not use silicone based furniture polish. Silicone in furniture polishes can break down the lacquer finish.

Missing parts

If you are missing any fixtures and fittings for your product please contact our customer service team on 0333 777 8999 and they will be happy to arrange for a replacement to be sent to you free of charge.

Warnings

We suggest you retain these instructions for future reference. Keep fittings out of children's reach and keep children well away from construction area. This product should only be used on firm level ground. Please periodically check all fittings and re-tighten as necessary.

Avoid exposing the furniture to excessive heat or direct sunlight as this can cause cracking of the wood and deterioration of the colour.

Unwrap all packaging materials and place the components top of the carton box or on a clean floor to protect it from damage.

Home service technicians

If you have a fault with your product please contact our customer service team on 0333 777 8999. If you have had the product for 28 days or less you may be offered a replacement, refund or for a fully trained home service technician to visit your home to assess the fault and repair the product where possible. If you have had the product for more than 28 days we will send an independent home service technician to review and repair the product where possible and recommend further action.

You can write to us at

Home Customer Services
Next Retail Ltd,
Desford Road,
Leicester
Le194 AT

To view our full furniture range
please visit www.next.co.uk

Need Help?

With: Assembly instructions
Missing or damaged parts
CALL: 0333 777 8999



SIERRA SWIVEL CHAIR

Assembly instructions

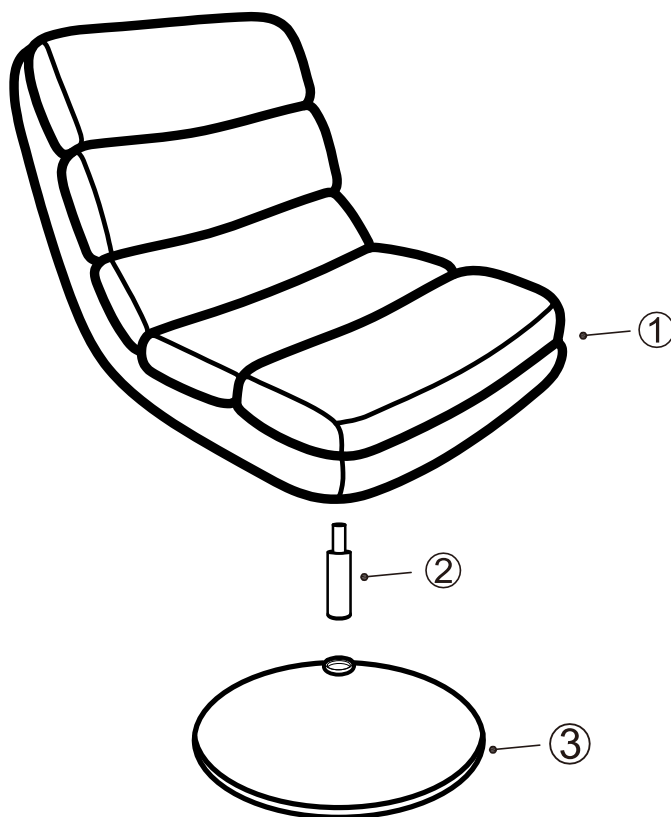
GETTING TO KNOW YOUR PRODUCT



Components supplied. Please use this guide if you require replacement parts.

Ref	Dimension	Visual	Qty
1	Seat: H48.5xW74xD52CM		1
2	Centre Support: 21x5.5CM		1
3	Base: 65x11CM		1

SIERRA SWIVEL CHAIR

Assembly instructions

1

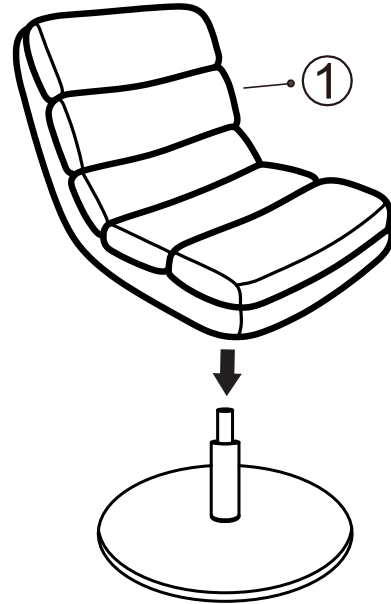
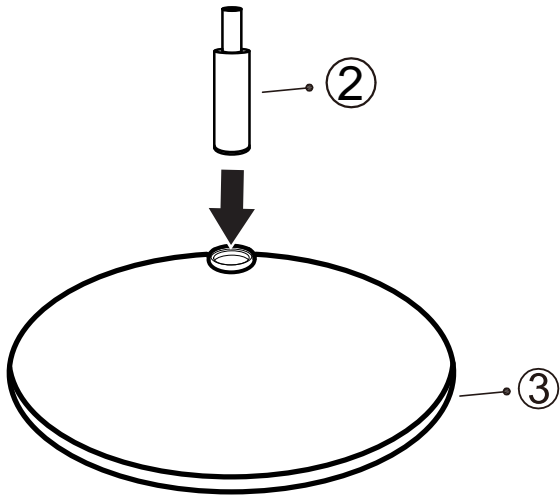

2

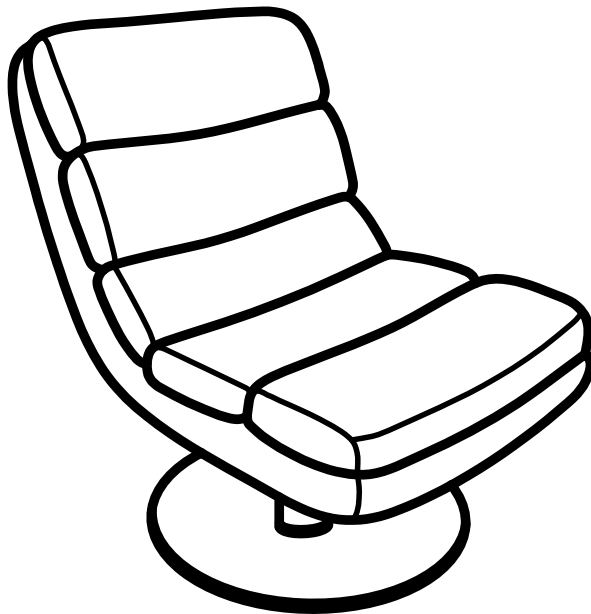

NEXT

SIERRA SWIVEL CHAIR

Assembly instructions

Actual product size
H93xW74xD92.5CM

CAUTION: Maxium weight capacity of this chair is 130kg.

